

# QRAE II User's Guide



**Covers QRAE II Diffusion & Pump Models  
with Firmware Version 3.60 or higher**

P/N 020-4100-000 Rev. F  
May 2013





# QRAE II User Guide

## Contents

<b>Read Before Operating</b> .....	<b>3</b>
<b>1 General Information</b> .....	<b>6</b>
1.1 Key Features .....	6
1.2 Specifications .....	7
<b>2 Charging The QRAE II Battery</b> .....	<b>8</b>
2.1 Low Voltage Warning.....	9
2.2 Clock Battery .....	9
<b>3 User Interface</b> .....	<b>10</b>
3.1 User Interface Icons .....	10
3.2 Turning The QRAE II On .....	11
3.3 Inverting The Display .....	13
3.4 Testing The Alarms (Anytime).....	13
3.5 Pump Status (QRAE II Pump Only).....	13
3.6 Turning The QRAE II Off .....	14
<b>4 Operating The QRAE II</b> .....	<b>15</b>
4.1 Mode Overview .....	15
4.2 Normal Mode .....	16
4.3 Diagnostic Mode.....	17
4.4 Adjusting The Pump Stall Threshold (QRAE Pump Only).....	21
4.4.1 Adjust Pump Stall: High.....	21
4.4.2 Adjust Pump Stall: Low .....	22
4.5 Programming Mode .....	24
4.5.1 Enter Programming Mode .....	25
4.5.2 Navigating Programming Mode .....	26
4.5.3 Calibrate Monitor .....	27
4.5.4 Change Alarm Limits .....	29
4.6 Change Datalog.....	32
4.7 Change Monitor Setup .....	36
4.8 Change Sensor Configuration .....	42
<b>5 Alarm Signal Summary</b> .....	<b>45</b>
<b>6 Bump Testing &amp; Calibrating The QRAE II</b> .....	<b>46</b>
6.1 Connecting the Calibration Gas To The Monitor (Pump Model Only).....	46
6.2 Connecting The Calibration Adapter (Diffusion Model Only).....	47
6.3 Disconnecting The Calibration Adapter (Diffusion Model Only).....	48
6.4 Zero (Fresh Air) Calibration .....	49
6.4.1 Using Fresh Air .....	49
6.4.2 Using Zero Gas.....	49
6.5 Multiple Sensor Calibration.....	50
6.6 Single Sensor Calibration .....	51
<b>7 Connecting To A Computer</b> .....	<b>53</b>
<b>8 Transferring Data To &amp; From A Computer</b> .....	<b>53</b>
8.1 Downloading The Datalog To A PC.....	53
8.2 Uploading Firmware To The QRAE II From A PC .....	54

# QRAE II User Guide

<b>9</b>	<b>Maintenance .....</b>	<b>55</b>
9.1	Replacing the QRAE II Li-Ion Battery .....	55
9.2	Installing The Alkaline Battery Adapter .....	56
9.3	Charging A Spare QRAE II Li-Ion Battery .....	57
9.4	Replacing Sensors .....	58
9.4.1	Sensor Locations .....	58
9.5	Replacing The Filter .....	60
9.6	Replacing The Pump (QRAE II Pump Model Only) .....	60
9.7	Cleaning .....	62
9.8	Firmware Updates .....	63
9.9	Ordering Replacement Parts .....	63
9.10	Electronic Waste Disposal .....	63
9.11	Year of Manufacture .....	63
<b>10</b>	<b>Troubleshooting .....</b>	<b>64</b>
<b>11</b>	<b>Technical Support.....</b>	<b>65</b>
<b>12</b>	<b>RAE Systems Contacts .....</b>	<b>66</b>
<b>13</b>	<b>Controlled Part of Manual.....</b>	<b>68</b>

## QRAE II User Guide

# WARNINGS

### Read Before Operating

This manual must be carefully read by all individuals who have or will have the responsibility of using, maintaining, or servicing this product. The product will perform as designed only if it is used, maintained, and serviced in accordance with the manufacturer's instructions.

### CAUTION!

Never operate the monitor when the cover is removed. Remove the monitor cover and battery only in an area known to be non-hazardous.
--

**Note:** Users are recommended to refer to ISA -RP12.13, Part II-1987 for general information on installation, operation, and maintenance of combustible gas detection instruments.

### Warranty Registration

Register your warranty online by visiting:

<http://www.raesystems.com/Support/ProductRegistration>

This ensures that your QRAE II is registered and ensures that we can let you know of important updates.

## QRAE II User Guide



Use only RAE Systems rechargeable battery pack part number 020-3402-000, or alkaline battery pack part number 020-3403-000. Use only DURACELL MN1500 batteries with alkaline battery pack. This instrument has not been tested in an explosive gas/air atmosphere having an oxygen concentration greater than 21%. Substitution of components may impair suitability for intrinsic safety. Recharge batteries only in non-hazardous locations. Do not connect the serial communication port in a hazardous location.

**STATIC HAZARD:** Clean only with a damp cloth.

For safety reasons this equipment must be operated and serviced by qualified personnel only. Read and understand instruction manual completely before operating or servicing.

All newly purchased RAE Systems instruments should be bump tested by exposing the sensor(s) to known concentrations of calibration gas.

The monitor should be calibrated if it does not pass a bump test, but no less than every 6 months, depending on use and exposure to gas and contamination, and its operational mode.

Bump test is defined as an exposure to gas that triggers the lowest alarm.

- Calibration intervals and bump test procedures may vary due to national legislation.
- When using the QRAE II with an H<sub>2</sub>S sensor, RAE Systems recommends using RAE calibration gas cylinders with a 4-gas mix containing 10 ppm H<sub>2</sub>S, 50 ppm CO, 50% LEL Methane, and 18% Oxygen.
- Any rapid up-scale reading followed by a declining or erratic reading may indicate a gas concentration beyond upper scale limit which may be hazardous.

## QRAE II User Guide



Utiliser seulement l'ensemble de batterie RAE Systems, la référence 020-3403-000.  
Utiliser uniquement des piles alcalines modèle DURACELL MN1500 avec l'adaptateur piles alcalines. Cet instrument n'a pas été testé dans une atmosphère de gaz/air explosive ayant une concentration d'oxygène plus élevée que 21%. La substitution de composants peut compromettre la sécurité intrinsèque. Ne charger les batteries que dans un emplacement désigné non dangereux. Ne reliez pas le port de communication série dans un endroit dangereux.

**RISQUE D'ORIGINE ELECTROSTATIQUE:** Nettoyer uniquement avec un chiffon humide.

Pour des raisons de sécurité, cet équipement doit être utilisé et entretenu uniquement par un personnel qualifié. Étudier le manuel d'instructions en entier avant d'utiliser, ou d'entretenir l'équipement.

Tout appareil neuf de RAE Systems doit préalablement passer le test de vérification d'étalonnage qui consiste à exposer le ou les capteurs à une concentration connue de gaz étalon.

Le détecteur doit être impérativement étalonné s'il ne passe pas le test de vérification d'étalonnage, ou bien au moins tous les 6 mois, selon l'utilisation et l'exposition à des gaz poisons ou des contaminants, et selon le mode opératoire.

Une vérification d'étalonnage est définie par une exposition du détecteur au gaz d'étalonnage qui doit déclencher le seuil d'alarmes bas.

- RAE Systems recommande d'utiliser les bouteilles d'étalonnage RAE Systems avec un mélange des quatre gaz suivant 10 ppm H<sub>2</sub>S, 50 ppm CO, 50% LIE méthane, et 18% d'oxygène.
- Toute variation de la lecture rapide et positive, suivie d'une baisse subite ou erratique de la valeur, peut indiquer une concentration de gaz hors gamme de détection qui peut être dangereuse.

# QRAE II User Guide

## 1 General Information

**QRAE II** is a programmable multi-gas monitor, available in pumped and diffusion models, designed to provide continuous exposure monitoring of oxygen, hydrogen sulfide, carbon monoxide and combustible gases for workers in hazardous environments. It monitors with the following types of sensors:

1. Combustible gases are monitored with catalytic bead sensors.
2. Hydrogen sulfide (or sulfur dioxide) and carbon monoxide are monitored with electrochemical sensors.
3. Oxygen is monitored with a solid polymer electrolyte (SPE) sensor.

### 1.1 Key Features

#### **Lightweight and Compact**

9 oz (250 g) diffusion model, 12 oz (350 g), pump version, handheld size.

#### **Dependable and Accurate**

QRAE II diffusion model: 14 hours of monitoring with microcontroller.

QRAE II Pump model: minimum 10 hours on Li-Ion battery, and 8 hours on alkaline battery

#### **User Friendly**

Menu-driven, intuitive end-use operation.

#### **Programmable Alarm Thresholds**

Audio buzzer and flashing display alarm.

- Standard configuration includes CO, H<sub>2</sub>S, LEL, and O<sub>2</sub> sensors
- Replaceable, rechargeable Li-Ion battery
- Large, easy-to-read display
- Datalogging with large memory
- Visual alarm with bright red flashing LEDs
- Loud audible alarm (95dB at 30 cm)
- Vibration alarm
- Rugged weather-resistant composite case
- Diffusion model and pump model



# QRAE II User Guide

## 1.2 Specifications

### QRAE II Specifications

<b>Configuration</b>	Pumped or diffusion 4-gas with datalogging		
<b>Dimensions:</b>	Diffusion: 5" L x 2.8" W x 1.5" H (125mm x 72mm x 38mm) Pump: 5" L x 2.8" W x 1.5" H (125mm x 72mm x 38mm)		
<b>Weight:</b>	Diffusion: 9 oz (250g) Pump: 12 oz (350 g) with battery		
<b>Detectors:</b>	2 Electrochemical toxic gases sensors 1 Solid Polymer Electrolyte oxygen sensor 1 Catalytic sensor for combustible level organics		
<b>Battery:</b>	Rechargeable 3.7V Li-ion battery pack (6-hour charge time) or a 3 AA alkaline battery adapter.		
<b>Operating Time:</b>	Up to 10 hours continuous w/ Li-ion battery pack		
<b>Display:</b>	4-line graphical LCD with automatic LED backlight for dim lighting conditions		
<b>Keypad:</b>	2 programming/operation keys		
<b>Direct Readout:</b>	Up to 4 simultaneous values with sensor name, battery charge, high and low values for all sensors, elapsed time, and datalogging on/off state		
<b>Sampling Method:</b>	Diffusion or pumped (depending on model)		
<b>Range, Resolution &amp; Response Time:</b>	LEL	0-100%	1 % 15 sec
	O <sub>2</sub>	0-30%	0.1 % 20 sec
	CO	0-1000 ppm	1 ppm 25 sec
	H <sub>2</sub> S	0-100 ppm	0.1 ppm 30 sec
<b>Alarm Settings:</b>	Separate limits for TWA, STEL, High, Low		
<b>Alarms:</b>	≥95 dB @ 30 cm buzzer, flashing red LEDs, vibration alarm, LCD to indicate exceeded preset limits, low battery, or sensor failure		
<b>Calibration:</b>	Two-point field calibration for fresh air and standard reference gas		
<b>Protection:</b>	Password protected calibration settings, alarm limits, and data		
<b>Intrinsic Safety:</b>	CSA Class I, Division 1, Group A, B, C, D, T4 (US & Canada), SIRA ATEX II 2G Ex ia d II C T4 Gb (Europe), IECEx Ex d ia II C T4 Gb		
<b>EM Immunity:</b>	No effect when exposed to 0.43mW/cm <sup>2</sup> RF interference (5-watt transmitter at 12"/10cm).		
<b>Data Storage:</b>	64,000 readings (64 hours, 4 channels at 1 minute interval) in non-volatile memory.		
<b>Datalog Interval:</b>	Programmable 1- to 3,600-second intervals		
<b>Alarm Settings:</b>	Separate alarm limit settings for TWA, STEL, Low and High alarm.		
<b>Communication:</b>	Download data to PC and upload monitor setup from PC through an RS-232 link to PC serial port		
<b>Temperature:</b>	-20° C to 50° C (-4° F to 122° F)		
<b>Humidity:</b>	0% to 95% relative humidity (non-condensing)		

#### Caution:

Refer to RAE Systems Technical Note TN-114 for sensor cross-sensitivities.  
Refer to RAE Systems Technical Note TN-144 for LEL sensor poisoning.

# QRAE II User Guide

## 2 Charging The QRAE II Battery

Always fully charge the battery before using the QRAE II. The QRAE II's Li-ion battery is charged by placing the QRAE II in its cradle. Contacts on the bottom of the QRAE II meet the cradle's contacts, transferring power without other connections.

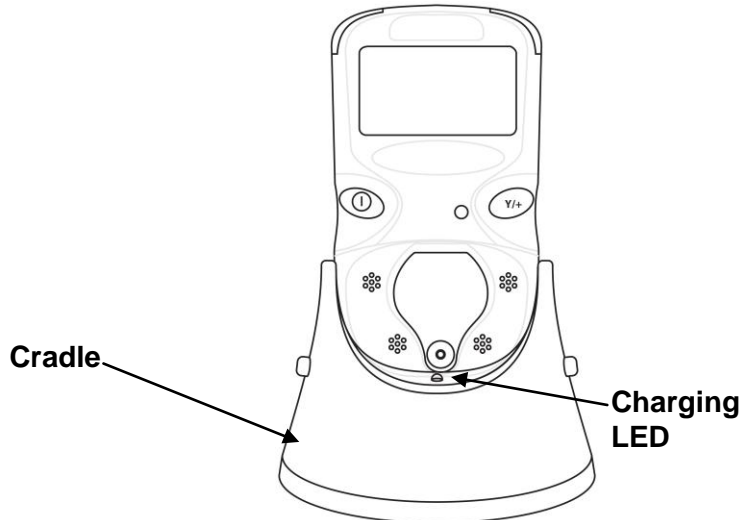

**Note:** Before setting the QRAE II into its charging cradle, visually inspect the contacts to make sure they are clean. If they are not, wipe them with a soft cloth. Do not use solvents or cleaners.

Follow this procedure to charge the QRAE II:

1. Plug the AC/DC adapter into the QRAE II's cradle.
2. Plug the AC/DC adapter into the wall outlet.
3. Place the QRAE II into the cradle and press down until the LED glows.

The QRAE II begins charging automatically. The LED in the cradle should glow red to indicate charging. During charging, the display shows this message:

### Charging...

At the same time, the voltage is indicated in the QRAE II's display, as well as an electrical plug icon is shown next to the battery:



When the QRAE II's battery is fully charged, the message "Fully Charged!" is shown in the display, and the icons for the electrical plug and the battery are shown.

When charging is complete, the LED in the cradle glows green.

# QRAE II User Guide

**Note:** A spare battery can be charged by placing it directly on the charging cradle. See “Charging A Spare QRAE II Battery” on page 57 for details.

**Note:** An Alkaline Battery Adapter (part number 020-3403-000), which uses three AA alkaline batteries, may be substituted for the Li-Ion battery. See page 47 for details.

## **WARNING!**

**To reduce the risk of ignition of hazardous atmospheres, recharge batteries only in areas known to be non-hazardous. Remove and replace batteries only in areas known to be non-hazardous.**

### **2.1 Low Voltage Warning**

When the battery’s charge falls below the shutoff voltage, the display shows:

**Battery low,  
turning off. . .**

The QRAE II then turns itself off. Recharge the battery by placing the QRAE II in its cradle.

### **2.2 Clock Battery**

An internal clock battery is mounted on one of the QRAE II’s printed circuit boards. This long-life battery keeps settings in memory from being lost whenever the Li-ion battery or alkaline batteries are removed. This backup battery should last approximately five years, and must be replaced by an authorized RAE Systems service technician. It is not user-replaceable.

# QRAE II User Guide

## 3 User Interface

The QRAE II's user interface consists of the display, LEDs, an alarm transducer, and two keys, labeled [MODE] and [Y/+]. The LCD display provides visual feedback that includes time, sensor mode, battery condition, and datalog enable/disable status.

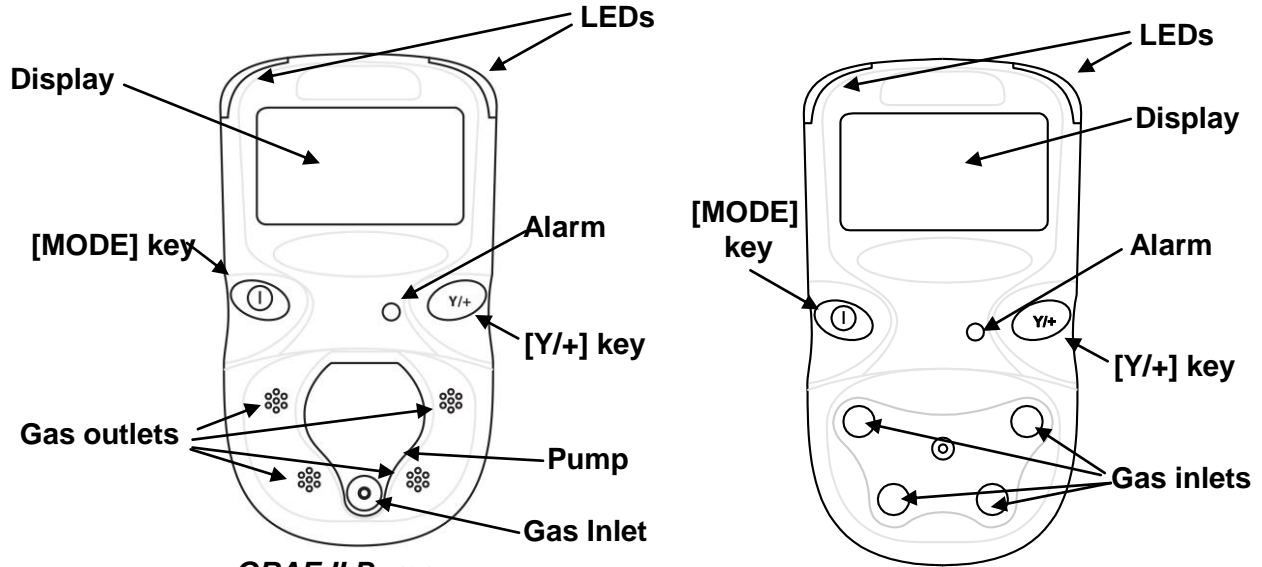

*QRAE II Pump*

*QRAE II Diffusion*

### 3.1 User Interface Icons

Icon	Indication
	Battery Voltage low (flashing) Battery Low alarm triggered
	Battery fully charged
	Battery charging
	Alkaline Battery Adapter in use
	Alkaline Battery cannot be charged
	Pump
	Pump blocked (blinks on and off)
	Datalogging active (flashing)
	Datalog memory full

# QRAE II User Guide

## 3.2 Turning The QRAE II On

To turn the QRAE II on, hold down [MODE] for 2 seconds.

**Caution:** The alarm is very loud. During startup, you can mute most of the sound by holding a finger over the alarm port.

**Note:** Do not put tape over the alarm port to permanently mute it.

When starting up, the QRAE II simultaneously turns the backlight on and off, beeps once, blinks once, and vibrates. The screen shows:

**On...**

**RAE Systems Inc.  
QRAE II  
(Language)**

This is followed by a progression of screens that tell you the QRAE II's current settings:

- Firmware version number and serial number (**Note:** not shown in fast-startup mode)
- List of installed sensors

If the QRAE II is set for Normal Startup, it proceeds to the following steps. However, if the QRAE II is set for Fast Startup (see page 39 for details), then it skips the following steps.

- Last Calibration date and time
- Alarm Mode, battery voltage, shutoff voltage
- Datalog Time Left

The QRAE II checks the oxygen sensor to determine whether it needs conditioning. If the sensor is new or has been in a QRAE II with its battery removed for a long period, it requires conditioning. If conditioning is required, it can take anywhere from 150 seconds to several minutes.

Because the oxygen sensor is a biased sensor, the QRAE II checks for abnormal readings during startup. This is not normally displayed, but if a battery or a sensor is replaced, this means the sensor loses bias and requires a little time to stabilize its reading again.

## QRAE II User Guide

If the reading is about 25% oxygen after a conditioning cycle, the monitor offers two options in its display:

1. **Wait.** This means that the monitor will run a second cycle of conditioning.
2. **Measure.** This means that the QRAE II will exit the conditioning menu and continue the start-up process.

**Note:** The time necessary for conditioning depends on how long the monitor has been without power. If two conditioning cycles are run, and conditioning still has not occurred, then the monitor may have drifted (or a sensor has been replaced). Therefore, a fresh air calibration is required. Select “Measure” and perform a fresh air calibration. Observe the reading for 5 minutes to ensure the sensor is stable.

After checking the oxygen conditioning, the QRAE II checks the calibration due date that has been set, and if that date has passed, a message prompting you to calibrate the monitor is displayed, “Cal due expired!” Press either key to continue (there is a “Continue” prompt). Once the monitor has finished startup, you should perform a calibration.

If “Power On Zero” is activated (see page 44 for details), the display shows the following message that prompts you to perform a fresh air calibration:

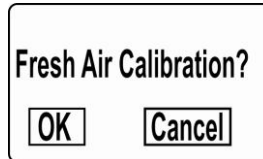

If you want to perform a fresh air calibration, refer to the steps outlined on page 27, and then press [MODE] for “OK” to start the fresh air calibration. Otherwise, press [Y/+] for “Cancel.”

The QRAE II performs a final checkout and the screen shows a countdown to full operational functionality.

If Datalog is on, this message is displayed after the countdown:

### Datalog Started

When the QRAE II is ready for use, it shows this screen:

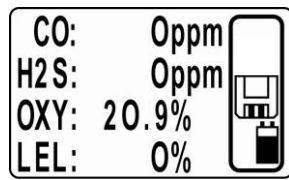

**QRAE II Diffusion**

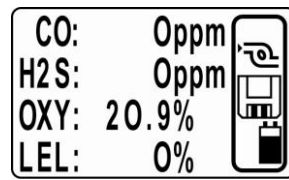

**QRAE II Pump**

## QRAE II User Guide

**Note:** If datalogging is off, you will not see the datalogging icon (see User Interface Icons, page 10).

### 3.3 Inverting The Display

The QRAE II is easy to read, whether held in the hand or clipped to a belt. To flip the screen, press the [Y/+] key and hold it down for 3 seconds. When the image inverts, release the key.

### 3.4 Testing The Alarms (Anytime)

Under normal non-alarm conditions, the buzzer, vibration alarm, LED, and backlight can be tested at any time by pressing [Y/+] once.

### 3.5 Pump Status (QRAE II Pump Only) IMPORTANT!

During operation, make sure the pump inlet is free of obstructions. Obstructions can cause premature wear on the pump, false readings, or pump stalling. During normal operation, the pump icon alternately shows inflow and outflow as shown here:



If there is a pump failure or obstruction that disrupts the pump, you will see this icon blinking on and off:



If you see this blinking icon, consult the Troubleshooting section of this guide.

#### **WARNING!**

Always operate the QRAE II Pump with an external filter.

## QRAE II User Guide

### 3.6 Turning The QRAE II Off

Press and hold [MODE]. In 2 seconds, a 5-second countdown to shutoff begins. You must hold your finger on the key for the entire shutoff process. If you remove your finger from the key during the countdown, the shutoff operation is canceled and the QRAE II continues normal operation.

The countdown proceeds as follows, accompanied at each step with an alarm beep and light flash. The display shows the countdown in sequence:

**Unit off in 5 seconds...**

**Unit off in 4 seconds...**

**Unit off in 3 seconds...**

**Unit off in 2 seconds...**

**Unit off in 1 seconds...**

**Unit off in 0 seconds...**

**Unit off...**

When you see “Unit off...” release your finger from the [MODE] key. The QRAE II is now off.

**Caution:** The alarm is very loud. During shutdown, you can mute most of the sound by holding a finger over the alarm port.



## 4 Operating The QRAE II

### 4.1 Mode Overview

The QRAE II has three operational modes:

- **Normal** — see page 16 for detailed instructions.
- **Diagnostic** — see page 17 for detailed instructions.
- **Programming** — see page 24 for detailed instructions.

**The following is an overview of the three modes:**

**Normal Mode** is the default mode. It is accessed when you turn on the QRAE II. There are no access restrictions (you do not need a password), and it provides the indications and data you need most for typical monitoring applications, including:

- Readings of carbon monoxide (CO), hydrogen sulfide (H<sub>2</sub>S), oxygen, and lower explosive limit (LEL)
- Peak
- Min (minimum)
- STEL (short-term exposure limit)
- TWA (time-weighted average)
- Battery level and shutoff voltage
- Run time since the QRAE II was turned on
- Time, date, and temperature
- Name of the LEL span gas used for calibration and the measurement gas

Normal Mode also allows you to turn datalogging on and off and communicate with a PC to download data.

**Diagnostic Mode** is primarily designed for technicians during troubleshooting, although it also offers access to a few changeable parameters that you may rarely (if ever) change. You must use a password to enter Diagnostic Mode. In Diagnostic Mode, QRAE II displays readings in raw counts (cts) and units (% or ppm).

- Sensor set
- Battery type indicator (Li-ion or alkaline)
- Display Contrast\*
- Backlight level and threshold\*
- Pump stall thresholds\*

Parameters marked with an asterisk (\*) can be adjusted by entering Programming Mode from Diagnostic Mode. See Page 24 for details.

**Programming Mode** is password-protected and includes adjustable settings to accomplish the following:

# QRAE II User Guide

- Calibrate the monitor (this includes changing span gases and values, and selecting single or multiple sensor calibrations)
- Change alarm limits
- Change/enable/disable the datalog
- Change the monitor setup
- Change the sensor configuration

## 4.2 Normal Mode

Normal Mode is the default mode of the QRAE II when it is turned on. By using the [MODE] key, you can step through the screens that provide you with information from the sensors, as well as the QRAE II's current settings.

### Enter Normal Mode:

1. With the QRAE II turned off, press and hold [MODE].
2. When the display turns on, release the keys. The QRAE II is now operating in Normal Mode.

### To Exit Normal Mode:

Whenever you turn off the QRAE II, it will start up in Normal Mode, unless you intentionally place it in Diagnostic Mode. Follow the detailed instructions on entering Diagnostic Mode and Programming Mode for information on entering the other two modes.

After it is shut off, the QRAE II will automatically be in Normal Mode the next time you start it.

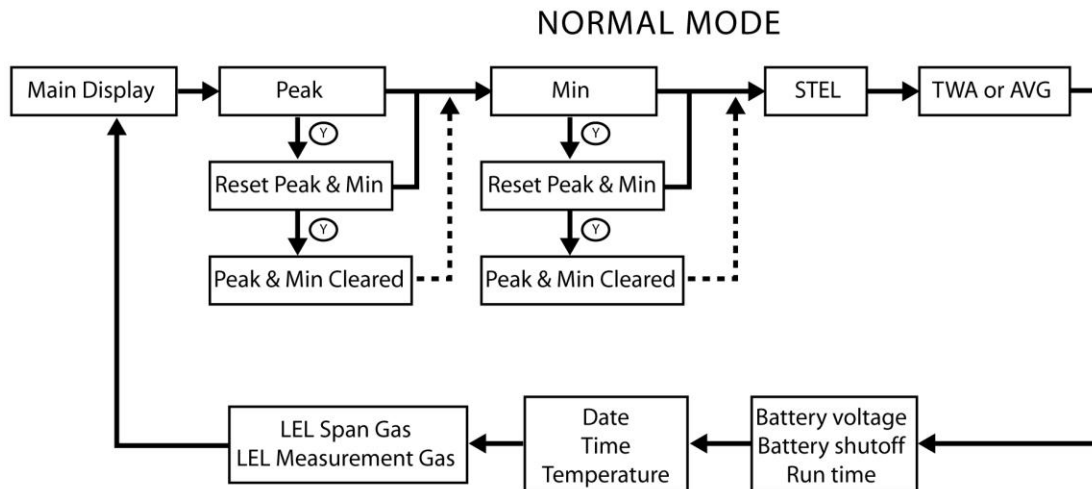

Use MODE key (M) to advance, except where noted.

**Peak.** This tells you the highest reading for each sensor since the QRAE II was turned on. Press [Y/+ ] twice to clear the Peak and Min or [MODE] once to advance to Min.

## QRAE II User Guide

**Min.** This tells you the lowest (minimum) reading for each sensor since the QRAE II was turned on. Press [Y/+] twice to clear the Peak and Min or [MODE] once to advance to STEL.

**STEL.** This provides Short Term Exposure Limit (STEL) data. These are based on 15-minute STEL values of H<sub>2</sub>S and CO in ppm and 8-hour Time Weighted Average (TWA).

**TWA.** The TWA (time-weighted average) reading is the average reading of the gas concentration times the fraction of 8 hours that the monitor has been on.

**AVG.** The AVG (average) is the running average from the time the monitor was turned on.

**Battery Voltage & Shutoff Voltage.** This tells you the battery's voltage right now and the voltage at which the QRAE II will shut off. This varies, depending on whether a Li-ion battery or an alkaline battery adapter is used.

**Run time.** This tells you in hours and minutes how much time has elapsed since the QRAE II was turned on. Run time resets to 0:00 every time the QRAE II is turned on.

**Date, Time, and Temperature.** The full date of month, day, and year, as well as the 24-hour time in hours, minutes, and seconds, is shown. Temperature is shown in degrees Fahrenheit or Celsius, depending on the user configuration (see Set Temperature Unit, page 39).

**LEL Span Gas, LEL Measurement Gas.** These two indications tell you the gas selected for performing a span and for performing a full measurement on the LEL sensor.

**Note:** If you access any screen in Normal Mode and leave that screen unattended for a few minutes, QRAE II automatically reverts to Normal Mode's main screen.

### 4.3 Diagnostic Mode

The QRAE II's Diagnostic Mode can only be accessed at startup time.

#### To Enter Diagnostic Mode:

1. With the QRAE II turned off, press and hold both [MODE] and [Y/+].
2. When you enter Diagnostic mode, you see the password screen:

**Enter Password?**

**0000**

**OK    Cancel**

3. Increase a number by pressing the [Y/+] key (1, 2, 3 ... etc.). **Note:** The numbers advance until the number 9 and then "wrap around" to 0 again.

## QRAE II User Guide

4. Advance to the next digit by pressing the [MODE] key (0000, 0000, etc.). **Note:** The display has a “wrap-around,” so once you reach the last digit, pressing [MODE] advances to the first digit again.
5. Once you are satisfied with the password, advance to OK, and press [MODE].
6. If you want to cancel, advance to Cancel and press the [MODE] key.  
If you use an incorrect password, the QRAE II will not enter Diagnostic Mode, and will instead enter Normal Mode.

**Note:** The default password is 0000. If you change the password, write it down and save it in a safe location. You do not have to change the password from 0000. You can simply continue using 0000, step through the digits and then press the [Y/+] key to enter Diagnostic Mode.

### To Exit Diagnostic Mode:

1. Turn off the QRAE II by pressing and holding [MODE]. There will be a standard shutoff countdown.
2. When it shuts off, you will be alerted. Release your finger.

**Note:** The next time you start QRAE II, hold only [MODE], and it will automatically be in Normal Mode.

When the QRAE II runs in Diagnostic Mode, the screen shows raw counts for sensors and battery levels (expressed as “cts,” short for “counts”). You can step through other diagnostic information by pressing the [MODE] key.

The items followed by an asterisk (\*) are user-changeable.

- Sensor set\*
- Battery type (Li-ion or alkaline)
- Display Contrast\*
- Backlight level and threshold\*
- Pump stall thresholds\*

**Note:** If the QRAE II is in its cradle, and the cradle is connected via its data cable to a PC, communication is possible in this mode.

# QRAE II User Guide

## DIAGNOSTIC MODE

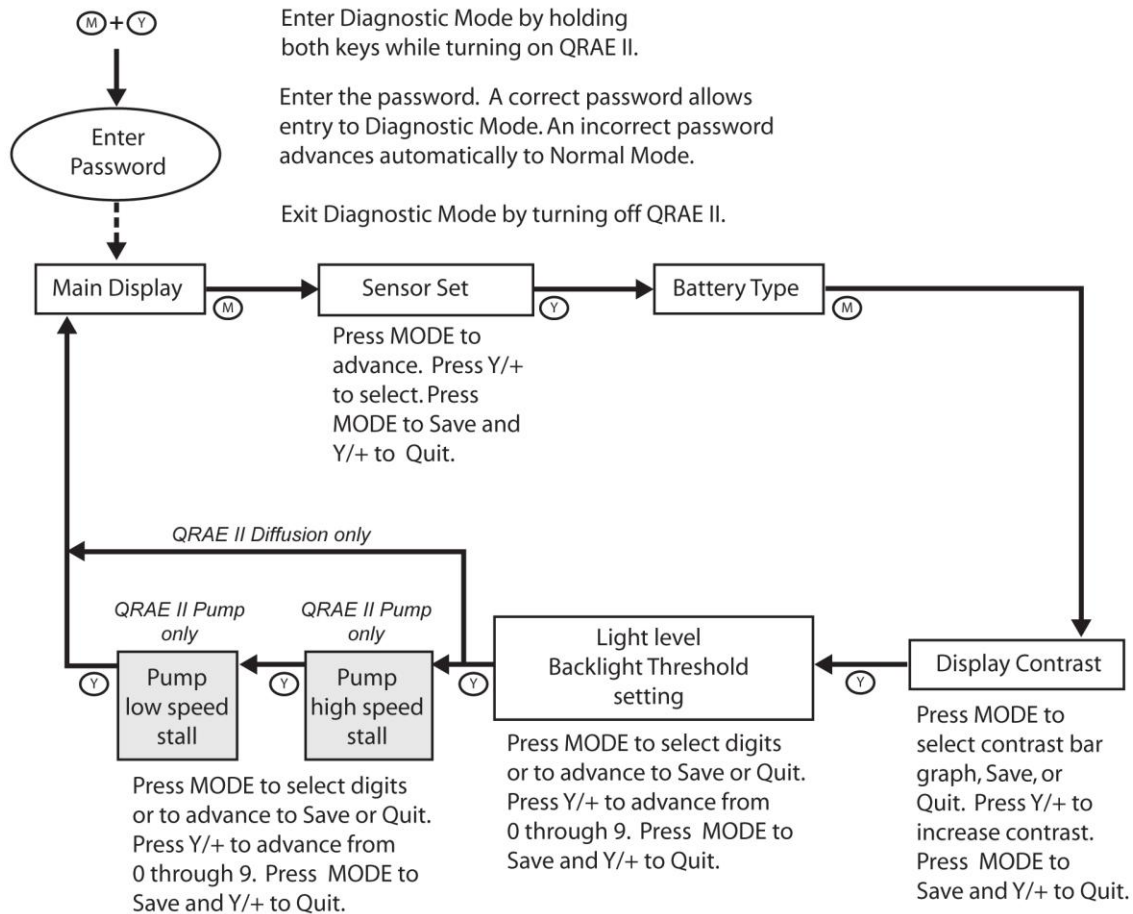

**Sensor Set.** Two sensor options are available. When any sensor is exchanged for another type, the firmware must be set to match the sensor. The upper right sensor slot can accommodate a CO sensor. The upper left sensor slot accommodates an H<sub>2</sub>S 0.1-100 ppm sensor.

The currently selected sensor is indicated by an asterisk (\*) to the left of the sensor's name. To change the selection:

1. Press [MODE] until first sensor is highlighted.
2. Repeatedly press the [MODE] button to advance through the sensors.
3. Press [Y/+ ] to make a selection.
4. Repeatedly press [MODE] until you reach Save or Quit.
  - Select Save and then press [Y+] to save the selection.
  - Select Quit and then press [Y/+ ] to exit from this menu and maintain the previously saved selection.

## QRAE II User Guide

**Important!** Always perform a full calibration after changing the setting or after replacing a sensor.

**Battery type.** This indicates the type of battery that is currently in use (Li-ion or alkaline).

**Display Contrast.** You can set the display contrast for maximum sharpness under the lighting conditions in which you are operating.

1. Press [MODE] until the bar graph blinks, showing it is selected.
2. Repeatedly press the [Y/+] button to incrementally increase the darkness of the display.

**Note:** Pressing [Y/+] several times causes the screen to appear fully dark. To return to a lighter screen, keep pressing [Y/+] until the screen suddenly becomes light again. This “wrap-around” feature ensures that you can correct for too much contrast setting.

3. Once the display contrast is set to your satisfaction, press [MODE], which will cause Save to blink. If you want to save the new setting, press [Y/+]. If you want to quit without saving the new setting, press [MODE] to advance to Quit. Then press [Y/+].

**Note:** The QRAE II’s default setting has the backlight turn on automatically and requires no adjustment. Whenever the amount of ambient light is lower than the QRAE II’s backlight threshold, the backlight automatically illuminates. The threshold can be adjusted (see Backlight Level and Threshold,” below), and the backlight can be set to manually turned on and off (see page 38).

**Backlight Level and Threshold.** Whenever the QRAE II’s backlight is in automatic mode and the amount of ambient light is lower than the Backlight Thresh Setting, the backlight illuminates.

This screen shows two values:

**Light:** The amount of ambient light where the QRAE is in operation.

**Backlight Thresh Setting:** The adjustable setting that sets the threshold at which the backlight illuminates when the QRAE II backlight is in automatic mode.

Set the threshold level for normal lighting conditions. However, if you are going to be in a dark location for extended periods and want to conserve battery power, you may want to set the QRAE’s backlight to operate in manual mode. See page 38 for details.

To set the backlight threshold:

1. Press [MODE] until first digit of the Backlight Threshold Setting value is highlighted.

## QRAE II User Guide

2. Press the [MODE] button to advance through the digits.
3. Press [Y/+] to increase the number.
4. Press [MODE] until you reach Save or Quit.
  - Select Save and then press [Y+] to save the selection.
  - Select Quit and then press [Y/+] to exit from this menu and maintain the previously saved selection.

### 4.4 Adjusting The Pump Stall Threshold (QRAE Pump Only)

If the gas inlet is blocked but the pump does not shut down, or the pump shuts down too easily with a slight blockage, the pump stall threshold value may be set too high or too low.

Enter Diagnostic Mode to perform the following adjustments.

#### 4.4.1 Adjust Pump Stall: High

This procedure sets the stall value for the pump's high-speed setting. See page 39 for directions on changing the pump speed from high to low, and vice versa.

1. In Programming Mode, set the pump to operate at High speed.

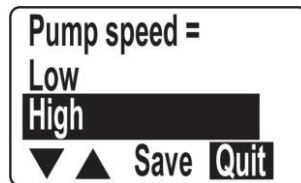

Exit Programming Mode, shut down the QRAE II, and then restart it in Diagnostic Mode.

In Diagnostic Mode, step through the menus until you come to Pump High Speed Stall.



- The display shows idle maximum and minimum values (for example, 46/41), plus the stall value with the pump operating at its high speed.
2. Write down the maximum reading. This is your unblocked reading.

## QRAE II User Guide

3. Block the inlet for 3 seconds. “I” (idle) maximum should increase at least 10 counts.

**Note:** If the increase is less than 10 counts, the pump is weak.

4. Write down the blocked reading for “I.”
5. Add the blocked number and the unblocked number and divide the total by 2 to arrive at the proper stall value. Here is an equation for this:

$$\text{Stall} = (\text{Idle}_{\text{max}} + \text{Block}_{\text{max}}) / 2$$

6. Set the stall value to this number.

### 4.4.2 Adjust Pump Stall: Low

This procedure sets the stall value for the pump’s low-speed setting. See page 39 for directions on changing the pump speed from high to low, and vice versa. **Note:** At low speed, if the inlet is blocked, the pump should stop working.

1. In Programming Mode, set the pump to operate at Low speed.

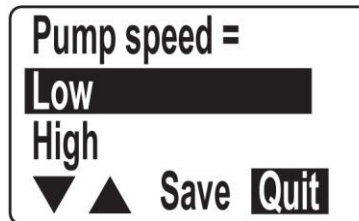

Exit Programming Mode, shut down the QRAE II, and then restart it in Diagnostic Mode.

In Diagnostic Mode, step through the menus until you come to Pump Low Speed Stall.

- The display shows idle maximum and minimum values (for example, 40/37), plus the stall value with the pump operating at its low speed.





## QRAE II User Guide

1. Write down the maximum reading. This is your unblocked reading.
2. Block the inlet for 3 seconds. “I” (idle) should increase at least 10 counts.

**Note:** If the increase is less than 10 counts, there is a leak in the gas inlet or the pump is weak.

3. Write down the blocked reading for “I.”
4. Add the blocked number and the unblocked number and divide the total by 2 to arrive at the proper stall value. Here is an equation for this:

$$\text{Stall} = (\text{Idle}_{\text{max}} + \text{Block}_{\text{max}}) / 2$$

5. Set the stall value to this number.

# QRAE II User Guide

## 4.5 Programming Mode

Programming Mode can be entered from Normal Mode or Diagnostic Mode. This mode contains most adjustable settings for the QRAE II. It is organized into five submenus:

- Calibrate Monitor
- Change Alarm Limits
- Change Datalog
- Change Monitor Setup
- Change Sensor Configuration

The following diagram shows how to enter Programming Mode from Normal Mode and from Diagnostic Mode:

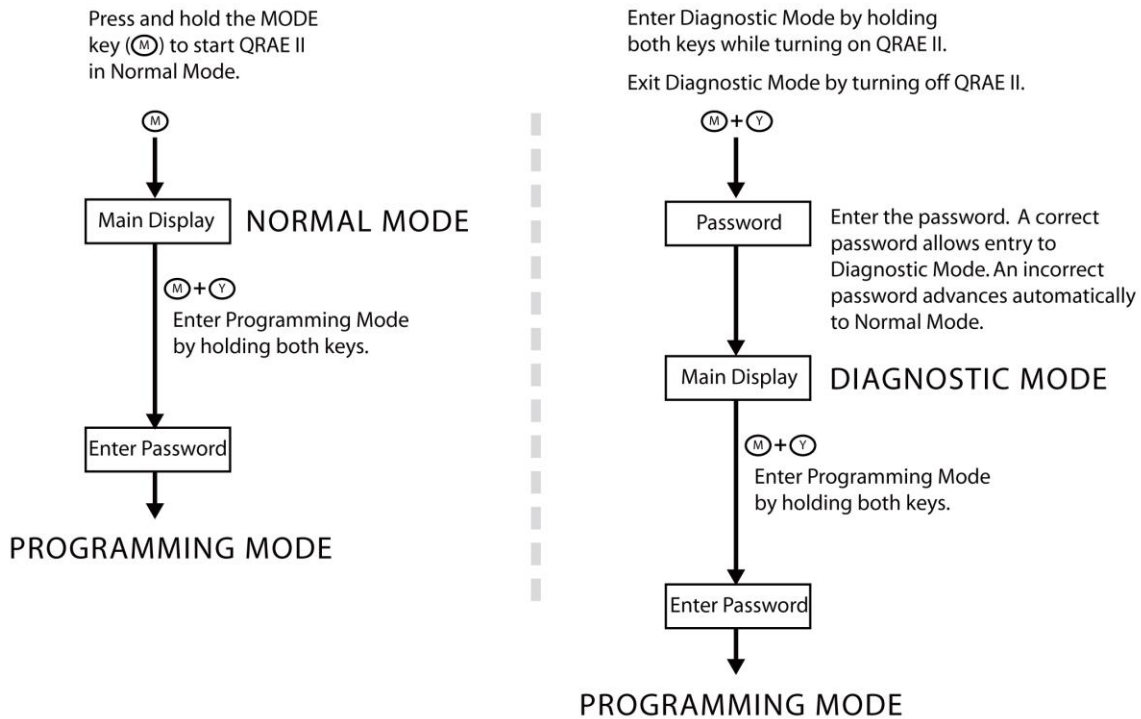

# QRAE II User Guide

## 4.5.1 Enter Programming Mode

To enter Programming Mode, hold down [MODE] and [Y/+] simultaneously for three seconds. To exit this mode, press [MODE] repeatedly until you see “Back.” Then press [Y/+] to select “Back.” Then the main concentration display shows.

When you enter Programming mode, you see:

**Enter Password?**

**0000**

**OK    Cancel**

Increase a number by pressing the [Y/+] key (1, 2, 3 ... etc.). **Note:** The numbers advance until the number 9 and then “wrap around” to 0 again.

Advance to the next digit by pressing the [MODE] key (0000, 0000, etc.). **Note:** The display has a “wrap-around,” so once you reach the last digit, pressing [MODE] advances to the first digit again.

Once you are satisfied with the password, advance to OK, and press [MODE]. If you want to cancel, advance to Cancel and press the [Y/+] key.

**Note:** The default password is 0000. If you change the password, write it down and save it in a safe location. You do not have to change the password from 0000. You can simply continue using 0000, step through the digits and then press the [Y/+] key to enter Programming Mode.

As Programming Mode is entered, datalogging is paused. A message that says “Datalog Paused!” briefly appears on the display before the first submenu item, “Calibrate Monitor” is shown.

# QRAE II User Guide

## 4.5.2 Navigating Programming Mode

The following diagram shows Programming Mode's five submenus and how to navigate through them.

**Note:** Press [MODE] to navigate from one menu choice to the next and [Y/+] to make selections.

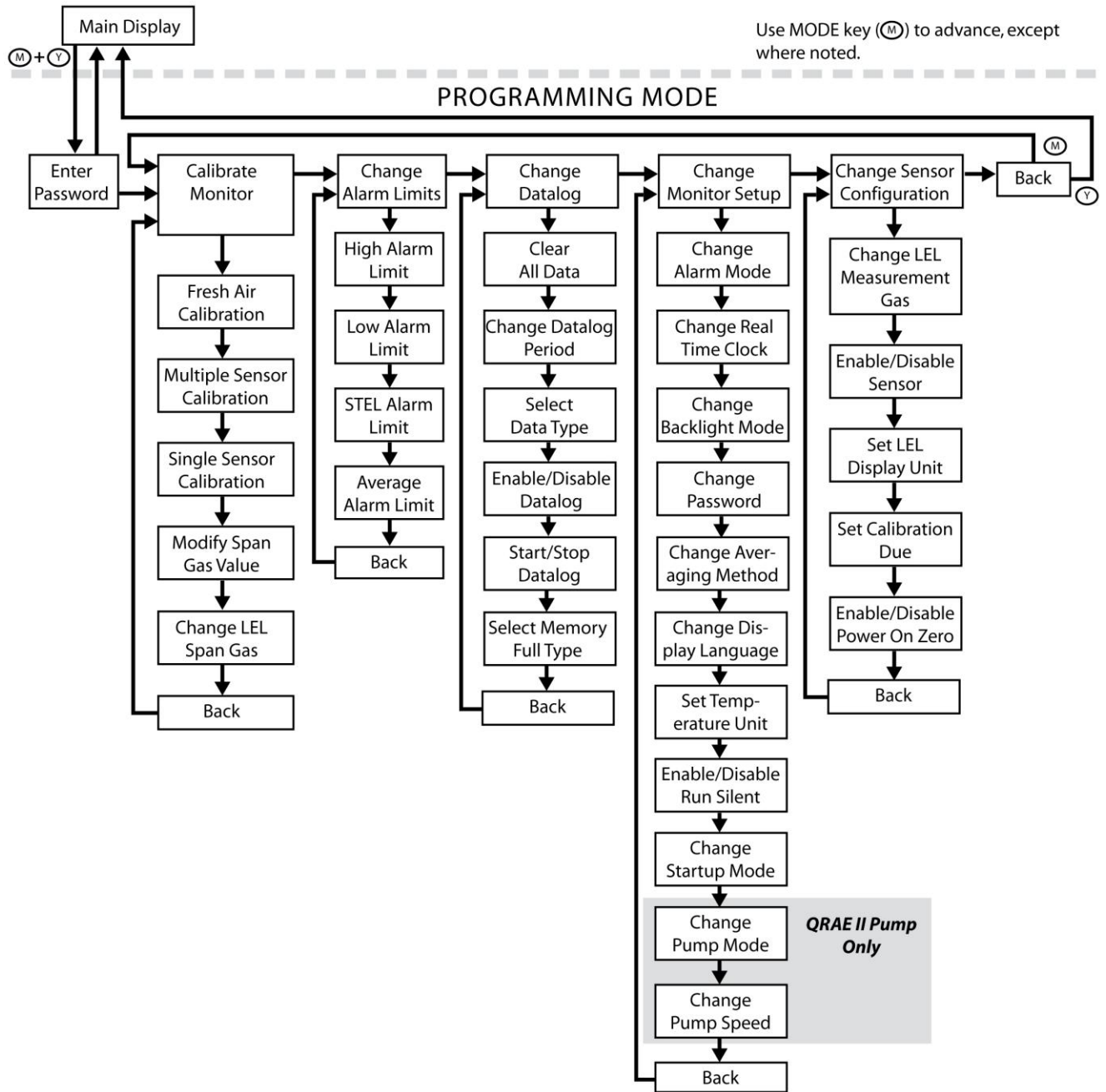

# QRAE II User Guide

## 4.5.3 Calibrate Monitor

The QRAE II is designed to perform automated calibrations.

**Note:** The procedures for calibration are covered in a separate section, “Calibrating The QRAE II,” on page 47.

The submenus and actions are shown in the following diagram.

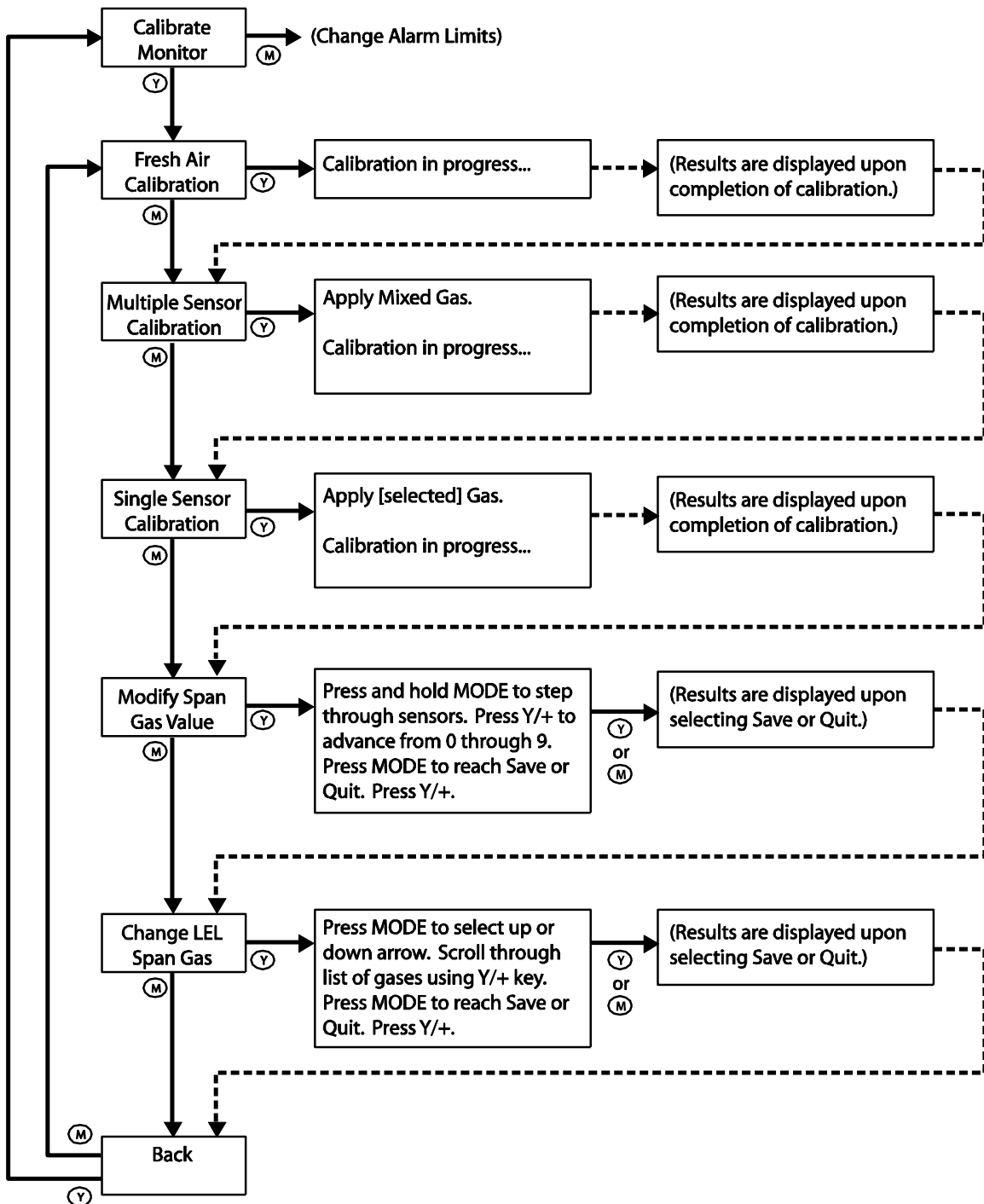

## QRAE II User Guide

**Fresh Air Calibration.** This sets the zero point of the sensor calibration curve for clean air. Expose the inlet to a clean air source with 20.9% oxygen and without any organic, toxic or combustible gas impurities. Follow the procedure outlined in “Zero (Fresh Air) Calibration” on page 49.

**Multiple Sensor Calibration.** This function simultaneously determines the second point of the calibration curve for multiple sensors in the monitor. To calibrate, follow the procedure outlined in “Calibrating The QRAE II,” on page 47.

**Single Sensor Calibration.** This procedure determines the second point of the sensor calibration curve for a single sensor. To calibrate, follow the procedure outlined in “Calibrating The QRAE II,” on page 47.

**Modify Span Gas Value.** This function allows selection of the gas concentration for each sensor.

### Setting the span value separately for each sensor.

1. Select a sensor by pressing [MODE] until the sensor’s name is highlighted.
2. Press [MODE] to advance through the digits on each sensor.
3. Press [Y/+] to increase the number (0 to 9).

**Note:** Once the number reaches 9, pressing [Y/+] returns to 0 and starts counting up again each time [Y/+] is pressed.

4. Press and hold [MODE] for 3 seconds and release to advance to the next sensor.
5. After you have set all of the span values, hold [MODE] for 3 seconds and release. Save is highlighted.
6. Press [Y/+] to save your settings, or [MODE] to advance to Quit (without saving settings).

If you choose to quit without saving the changes, press [Y/:]. You will see this message:

**Not Saved!**

If you want to make further changes to the settings, press [MODE] to repeat stepping through the sensors.

**Change LEL Span Gas.** This function allows selection of the gas to be used for span calibration of the LEL sensor. The correction for the measurement gas is automatically divided by the correction factor the span gas, selected previously, to obtain a new factor for the combination of gases. The new factor is applied to the readings to obtain a true concentration.

1. Press [MODE] until the up or down arrow is highlighted.
2. Press [Y/+] to move through the list of LEL span gases.

## QRAE II User Guide

3. Press [MODE] to select either the other arrow or to advance to Save or Quit.
4. With Save selected, press [Y/+] to save your settings, or [MODE] to advance to Quit (without saving settings).

If you choose to quit without saving the changes, press [Y/+]. You will see this message:

**Not Saved!**

If you want to make further changes to the settings, press [MODE] to repeat stepping through the choices.

**Back.** Press [MODE] to return to the top of the Calibrate Monitor menu, or press [Y/+] to return to the top of the Normal Mode menu.

### 4.5.4 Change Alarm Limits

The high and low alarm limits, as well as the points at which the STEL and TWA alarms are triggered, can be modified in this set of menus. Each sensor's limits for each of these can be set separately, providing extremely precise alarm thresholds.

**Alarm Signals.** During each measurement period, the gas concentration is compared with the programmed alarm limits (gas concentration alarm limit settings: Low, High, TWA and STEL). If the concentration exceeds any of the preset limits, the loud buzzer, red flashing LED, and vibration alarm are activated immediately to warn of the alarm condition. In addition, the QRAE II alarms if one of the following conditions occurs: battery voltage falls below a preset voltage level (3.1 volts for Li-ion, 3.3 volts for alkaline batteries), or when the datalog memory is full. When the low battery alarm occurs, there will be approximately 20 to 30 minutes of operating time remaining. When the battery voltage falls below the low threshold, the QRAE II turns off automatically.

Submenus in this section are:

- High Alarm Limit
- Low Alarm Limit
- Stel Alarm Limit
- Average Alarm Limit

The submenus and actions are shown in the following diagram:

## QRAE II User Guide

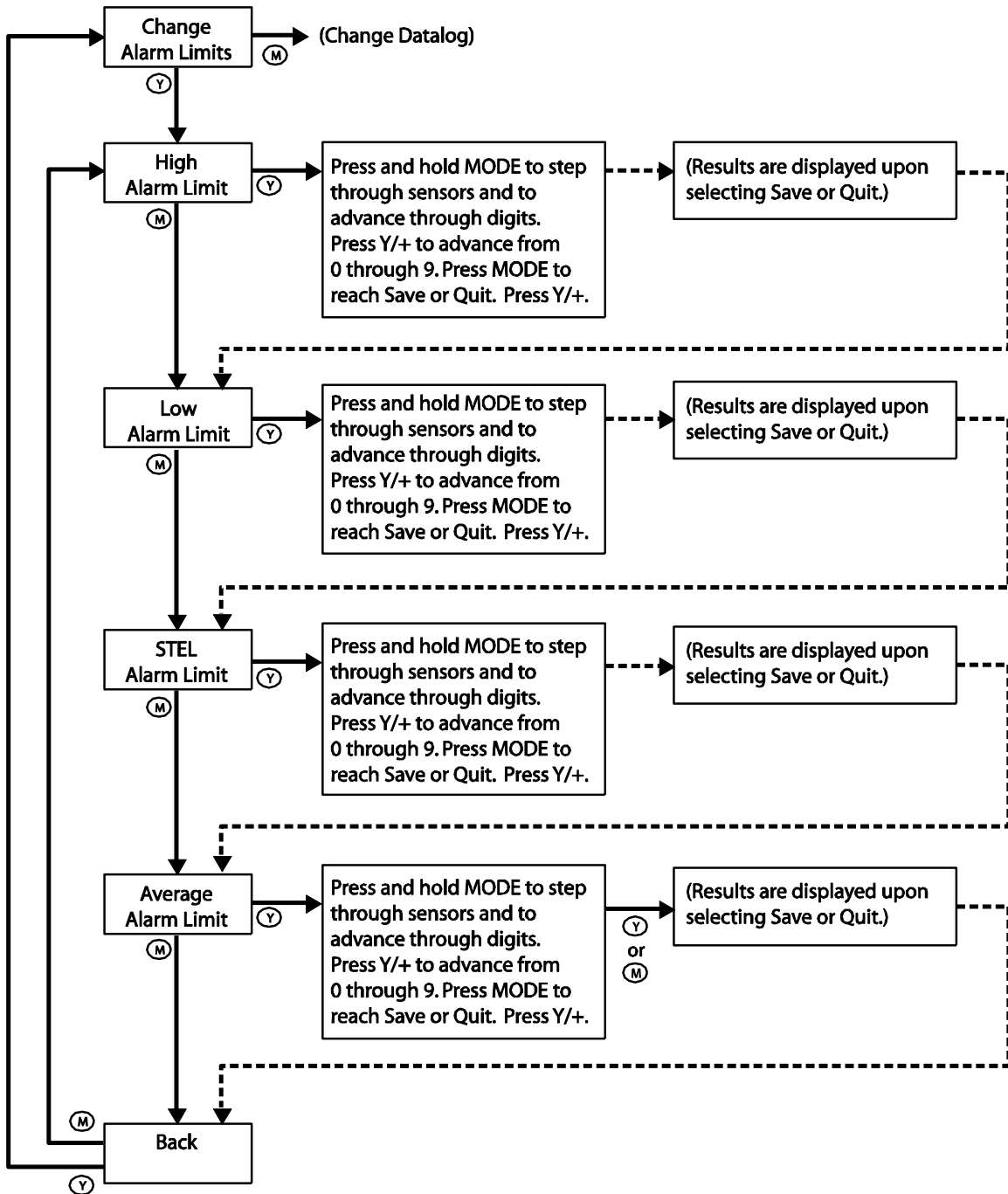

**Change High Alarm Limit.** This function allows you to selectively set the high limit of individual sensors in the QRAE II.

1. Select a sensor by pressing [MODE] until the sensor’s name is highlighted.
2. Press [MODE] to step through the sensor’s digits.
3. Press [Y/+] to increase the number from 0 through 9. Once the number 9 is reached, pressing [Y/+] causes the numbers to “wrap around” to 0 and count up again.



## QRAE II User Guide

4. Press and hold [MODE] for 3 seconds to advance to the next sensor.
5. Follow the same procedure as steps 2 and 3 for each sensor.

After you have modified all necessary sensor settings:

6. Press [MODE] to advance to Save or Quit.
7. With Save selected, press [Y/+] to save your settings, or [MODE] to advance to Quit (without saving settings).

**Change Low Alarm Limit.** This function allows you to selectively set the low limit of individual sensors in the QRAE II.

1. Select a sensor by pressing [MODE] until the sensor's name is highlighted.
2. Press [MODE] to step through the sensor's digits.
3. Press [Y/+] to increase the number from 0 through 9. Once the number 9 is reached, pressing [Y/+] causes the numbers to "wrap around" to 0 and count up again.
4. Press and hold [MODE] for 3 seconds to advance to the next sensor.
5. Follow the same procedure as steps 2 and 3 for each sensor.

After you have modified all necessary sensor settings:

6. Press [MODE] to advance to Save or Quit.
7. With Save selected, press [Y/+] to save your settings, or [MODE] to advance to Quit (without saving settings).

**Change STEL Alarm Limit.** This function allows you to selectively set the STEL (short term exposure limit) of individual sensors in the QRAE II. Note: This function does not include LEL or oxygen sensors.

1. Select a sensor by pressing [MODE] until the sensor's name is highlighted.
2. Press [MODE] to step through the sensor's digits.
3. Press [Y/+] to increase the number from 0 through 9. Once the number 9 is reached, pressing [Y/+] causes the numbers to "wrap around" to 0 and count up again.
4. Press and hold [MODE] for 3 seconds to advance to the next sensor.
5. Follow the same procedure as steps 2 and 3.

After you have performed all necessary modifications:

6. Press [MODE] to advance to Save or Quit.
7. With Save selected, press [Y/+] to save your settings, or [MODE] to advance to Quit (without saving settings).

## QRAE II User Guide

**Change Average Alarm Limit.** This function allows you to selectively set the STEL (short term exposure limit) of individual sensors in the QRAE II. Note: This function does not include LEL or oxygen sensors.

1. Select a sensor by pressing [MODE] until the sensor's name is highlighted.
2. Press [MODE] to step through the sensor's digits.
3. Press [Y/+] to increase the number from 0 through 9. Once the number 9 is reached, pressing [Y/+] causes the numbers to “wrap around” to 0 and count up again.
4. Press and hold [MODE] for 3 seconds to advance to the next sensor.
5. Follow the same procedure as steps 2 and 3.

After you have performed all necessary modifications:

6. Press [MODE] to advance to Save or Quit.
7. With Save selected, press [Y/+] to save your settings, or [MODE] to advance to Quit (without saving settings).

**Back.** Press [MODE] to return to the top of the Change Alarm Limits menu, or press [Y/+] to return to the top of the Normal Mode menu.

### 4.6 Change Datalog

The QRAE II calculates and stores the gas readings based on a user-specified datalogging period and the type of measurement. Average, peak and minimum values can be stored for each sensor during each datalogging interval. The datalogging interval can be programmed from one second to 3,600 seconds (60 minutes) in 1-second intervals. In addition, serial number, last calibration date, and alarm limits are stored. All data are retained in non-volatile memory for later download to a PC.

There are six submenus to Change Datalog:

- Clear All Data
- Change Datalog Period
- Select Data Type
- Enable/Disable Datalog
- Start/Stop Datalog
- Select Memory Full Type

# QRAE II User Guide

The following diagram shows the navigation of this set of submenus:

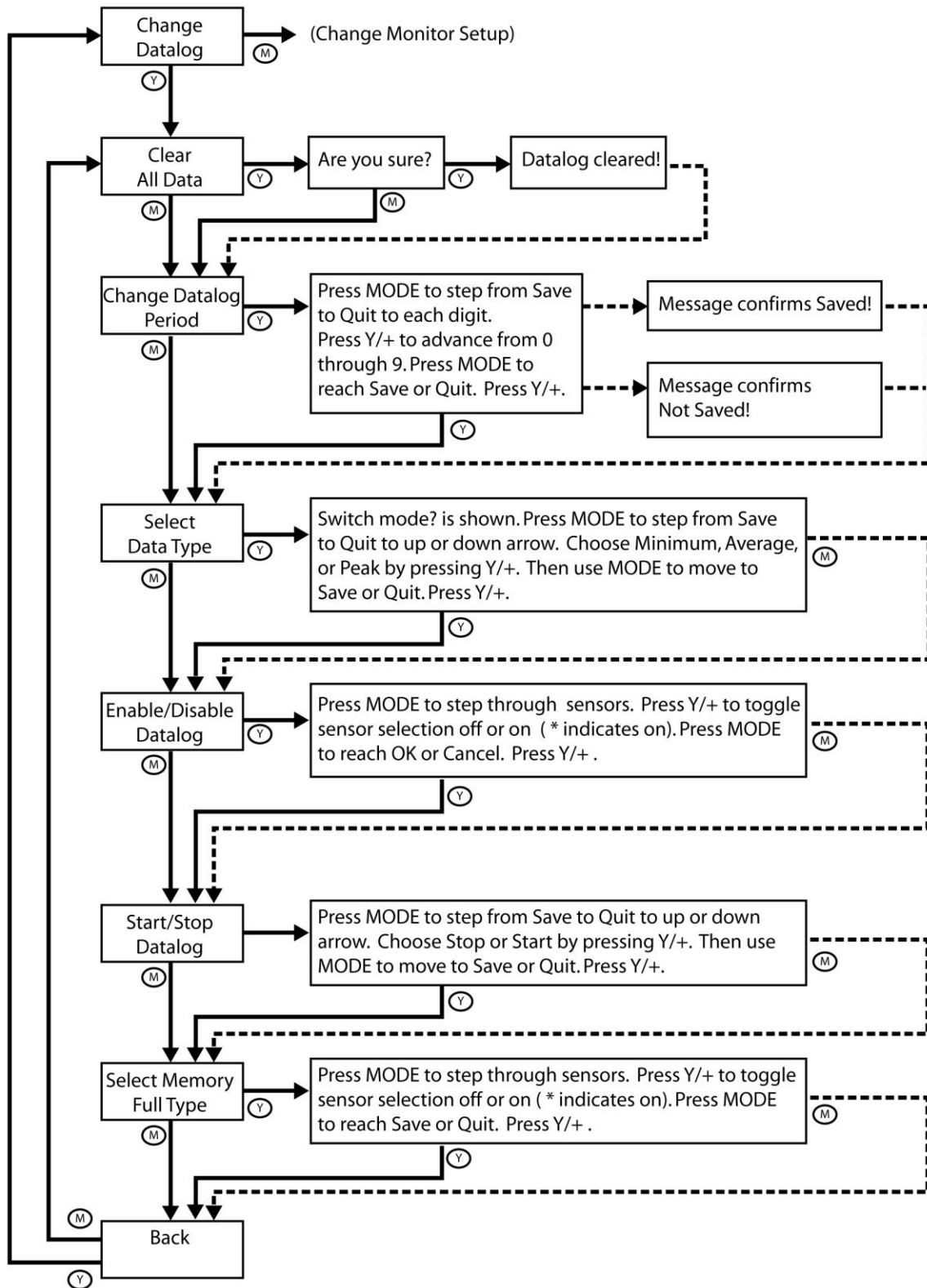

## QRAE II User Guide

**Clear All Data.** You can clear all data from the datalog. The QRAE II has a challenge that asks you to confirm that you want to clear the data.

1. Press [Y/+]. The display shows:

**Are you sure?**

2. Press [Y/+] to clear the datalog or [MODE] if you do not want to clear the datalog. If you choose to clear it, the display shows:

**Datalog cleared!**

If you press [MODE], the display shows:

**Datalog not cleared.**

**Important!** If you clear the datalog's data, it cannot be retrieved, or "unerased."

**Change Datalog Period.** The datalogging interval can be set from 1 second to 3,600 seconds (60 minutes). This is the time between data points. The QRAE II can store 64,000 datapoints.

1. Press [MODE] to step from Save and Quit and to advance through the digits.
2. Press [Y/+] to advance from 0 through 9. If you press [Y/+] when 9 is selected, it "wraps" around to 0 and begins counting up again each time you press [Y/+].
3. Press [MODE] to step to the next digit.
4. Press [Y/+] to advance from 0 through 9. Repeat steps 3 and 4 until you advance to Save or Quit.
5. Press [Y/+] to commit your change or to exit to the next menu item.

**Select Data Type.** You have three choices for the type of data collected in the QRAE II. You may select one. The screen shows:

**Switch mode?**

Your choices are:

- Average
- Peak
- Minimum

Press [MODE] to move from the up arrow to the down arrow to Save and to Quit. When the cursor is on the choice you want, press the [Y/+] key.

## QRAE II User Guide

**Enable/Disable Datalog?** You can selectively enable or disable the data from each sensor to be stored in the datalog. This requires turning on or off each sensor in the menu.

1. Select a sensor to enable/disable by pressing [MODE] until the sensor's name is highlighted.
2. Press [Y/+] to toggle the selection on (indicated by an asterisk, \*) or off (no asterisk).

To select other sensors to datalog, press [MODE] until you reach the sensor you want to select. Then press [Y/+].

After you have selected all the sensors you want enabled or disabled:

3. Press [MODE] to advance to OK or Cancel.

With OK selected, press [Y/+] to save your settings, or press [MODE] to advance to Cancel (without saving settings).

**Start/Stop Datalog?** You can manually start or stop the QRAE II's datalogging.

1. Select Stop or Start by pressing [MODE] until your choice is highlighted.
2. Press [MODE] to advance to Save or Quit.

With Save selected, press [Y/+] to save your settings, or press [MODE] to advance to Quit and then press [Y/+] to quit without saving your selection.

**Select Memory Full Type.** You can set how the QRAE II deals with a full datalog memory. Once the datalog is full, it can either stop (retaining all data to that point) or wrap around, meaning that it begins overwriting the earliest data and proceeding to replace old data in an ongoing manner.

1. Press [MODE] to step from Save to Quit to the up or down arrow.
2. Choose Stop or Wrap Around by pressing [Y/+].
3. Press [MODE] to step to Save or Quit.
4. Press [Y/+] to commit your change or to exit to the next menu item.

**Back.** Press [MODE] to return to the top of the Change Datalog menu, or press [Y/+] to return to the top of the Normal Mode menu.

### 4.7 Change Monitor Setup

This is the most extensive submenu set in the QRAE II. It includes:

- Change Alarm Mode
- Change Real Time Clock
- Change Backlight Mode
- Change Password
- Change Averaging Method
- Change Display Language
- Set Temperature Unit
- Enable/Disable Run Silent
- Change Startup Mode
- Pump Mode
- Change Pump Speed

The diagram on the next page shows how Change Monitor Setup is organized and how to navigate through it.

# QRAE II User Guide

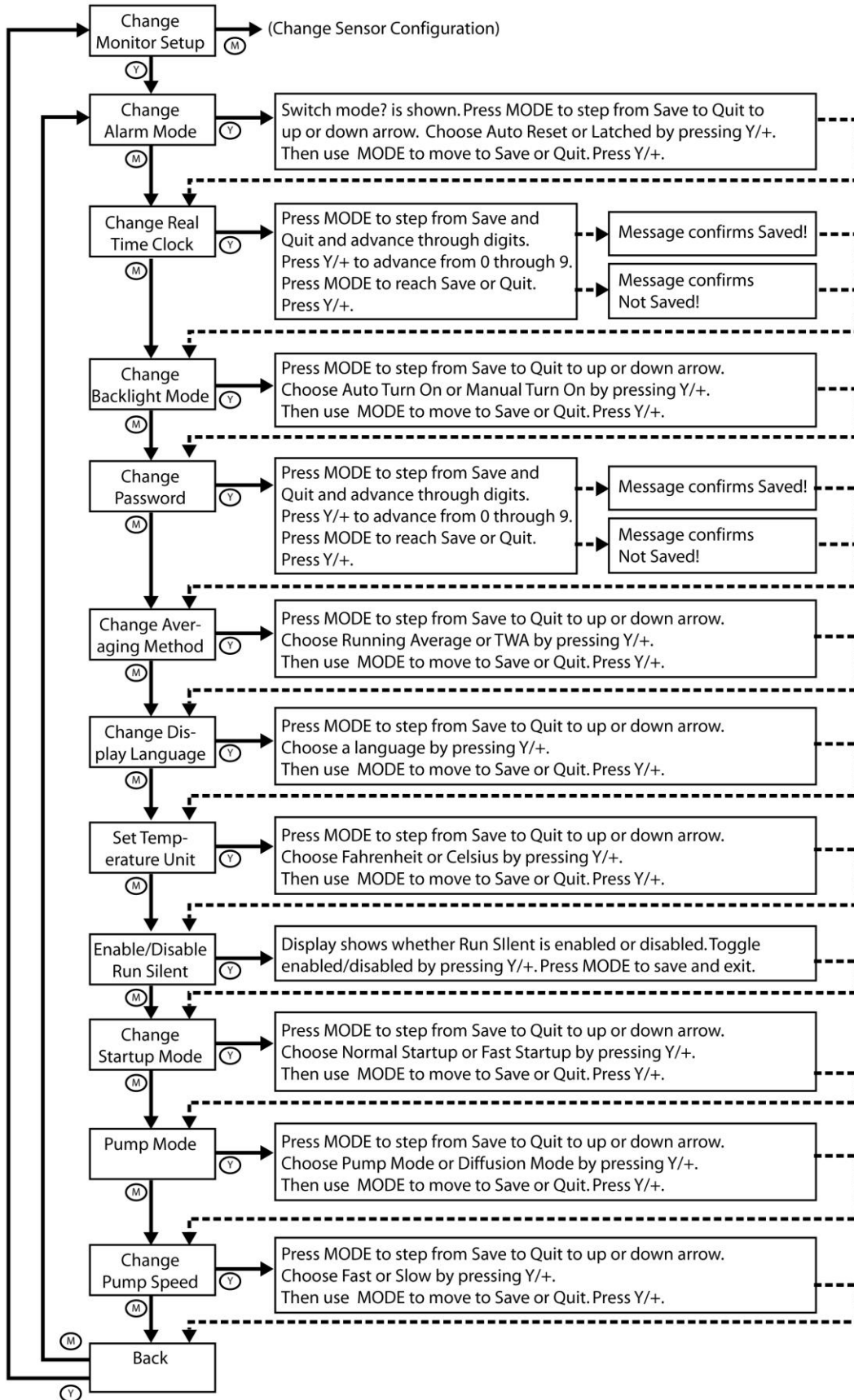

## QRAE II User Guide

**Change Alarm Mode.** Your choices are Auto Reset and Latched. A latched alarm stays in alarm until you acknowledge the alarm by pressing a button. An auto-reset alarm turns off when the condition that set off the alarm is no longer present (for instance, a high H2S reading that exceeds the preset threshold and triggers an alarm, but then lowers below that threshold, turning the alarm off).

1. Press [MODE] to step from Save to Quit to the up or down arrow.
2. Choose Auto Reset or Latched by pressing [Y/+].
3. Press [MODE] to step to Save or Quit.
4. Press [Y/+] to commit your change or to exit to the next menu item.

**Change Real Time Clock.** Date (month, day, year) and time (hour, minute, second) are adjustable. Time is in 24-hour mode.

1. Press [MODE] to step from Save and Quit and to advance through the digits.
2. Press [Y/+] to advance from 0 through 9. If you press [Y/+] when 9 is selected, it “wraps” around to 0 and begins counting up again each time you press [Y/+].
3. Press [MODE] to step to Save or Quit.
4. Press [Y/+] to commit your change or to exit to the next menu item.

**Change Backlight Mode.** In Manual Turn On, the backlight can be toggled on and off manually by pressing and holding [Y/-] for one second. In Auto Turn On, the backlight switches on automatically when the ambient light level exceeds a threshold. See Setting Backlight Mode on page 20 for details on setting the turn-on/turn-off threshold.

1. Press [MODE] to step from Save to Quit to the up or down arrow.
2. Choose Manual Turn On or Auto Turn On by pressing [Y/+].
3. Press [MODE] to step to Save or Quit.
4. Press [Y/+] to commit your change or to exit to the next menu item.

**Change Password.** You can change the 4-digit password from its default of 0000.

1. Press [MODE] to step from Save and Quit and to advance through the digits.
2. Press [Y/+] to advance from 0 through 9. If you press [Y/+] when 9 is selected, it “wraps” around to 0 and begins counting up again each time you press [Y/+].
3. Press [MODE] to step to Save or Quit.
4. Press [Y/+] to commit your change or to exit to the next menu item.

**Important!** If you change the password, write down the new password and save it.

**Change Averaging Method.** Toggle between Running Average and TWA (time-weighted average).

1. Press [MODE] to step from Save to Quit to the up or down arrow.
2. Choose Running Average or TWA by pressing [Y/+].



## QRAE II User Guide

3. Press [MODE] to step to Save or Quit.
4. Press [Y/+] to commit your change or to exit to the next menu item.

**Change Display Language.** Scroll from English to other languages (language options depend on firmware version).

1. Press [MODE] to step from Save to Quit to the up or down arrow.
2. Choose a language by pressing [Y/+].
3. Press [MODE] to step to Save or Quit.
4. Press [Y/+] to commit your change or to exit to the next menu item.

**Set Temperature Unit.** Select Fahrenheit or Celsius.

1. Press [MODE] to step from Save to Quit to the up or down arrow.
2. Choose Fahrenheit or Celsius by pressing [Y/+].
3. Press [MODE] to step to Save or Quit.
4. Press [Y/+] to commit your change or to exit to the next menu item.

**Enable/Disable Run Silent.** You can select Run Silent Enabled or Run Silent Disabled modes.

1. Toggle enabled or disabled by pressing [Y/+].
2. Press [MODE] to save your choice and to exit to the next menu item.

**Change Startup Mode.** Options are Normal Startup and Fast Startup. Fast Startup skips showing you many settings and is best suited to environments where the QRAE II is turned on and off very often during a given day.

1. Press [MODE] to step from Save to Quit to the up or down arrow.
2. Choose Normal Startup or Fast Startup by pressing [Y/+].
3. Press [MODE] to step to Save or Quit.
4. Press [Y/+] to commit your change or to exit to the next menu item.

# QRAE II User Guide

The diagram below shows the difference between the two startup modes:

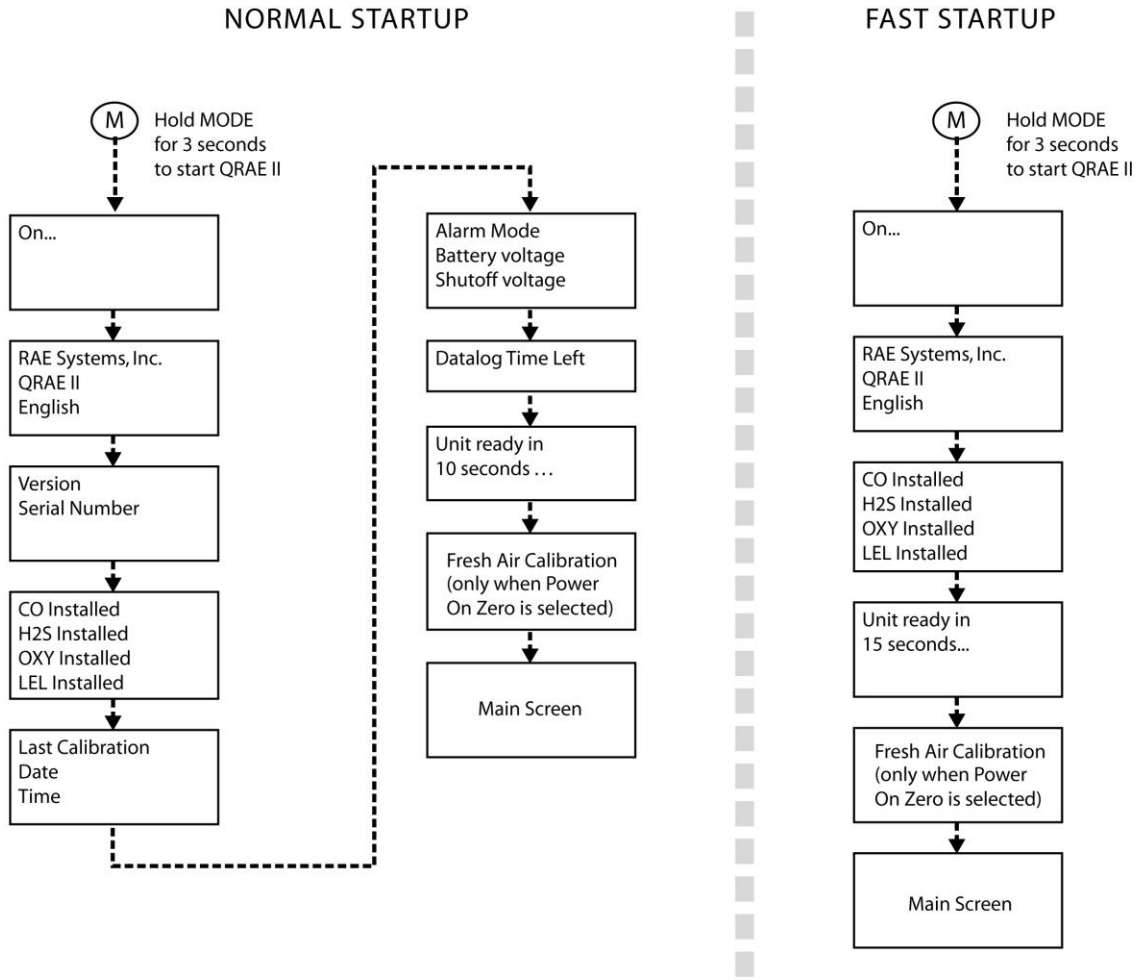

## QRAE II User Guide

**Pump Mode.** Options are Pump Mode and Diffusion Mode.

**Caution:** Only use Pump Mode with a QRAE II outfitted with a pump, and only use Diffusion Mode with a QRAE II without a pump.

1. Press [MODE] to step from Save to Quit to the up or down arrow.
2. Choose Pump Mode or Diffusion Mode by pressing [Y/+].
3. Press [MODE] to step to Save or Quit.
4. Press [Y/+] to commit your change or to exit to the next menu item.

**Change Pump Speed.** Options are Fast and Slow.

**Note:** The “Change Pump Speed” menu option only applies when Pump Mode is selected. Therefore, it does not apply to the QRAE II Diffusion model.

1. Press [MODE] to step from Save to Quit to the up or down arrow.
2. Choose Fast or Slow by pressing [Y/+].
3. Press [MODE] to step to Save or Quit.
4. Press [Y/+] to commit your change or to exit to the next menu item.

**Back.** Press [MODE] to return to the top of the Change Monitor Setup menu, or press [Y/+] to return to the top of the Normal Mode menu.

## 4.8 Change Sensor Configuration

You can select which sensors are enabled/disabled, and change the type of LEL measurement gas and unit of display for LEL in this set of submenus.

The following diagram shows how Change Sensor Configuration's menus are organized and how to navigate them:

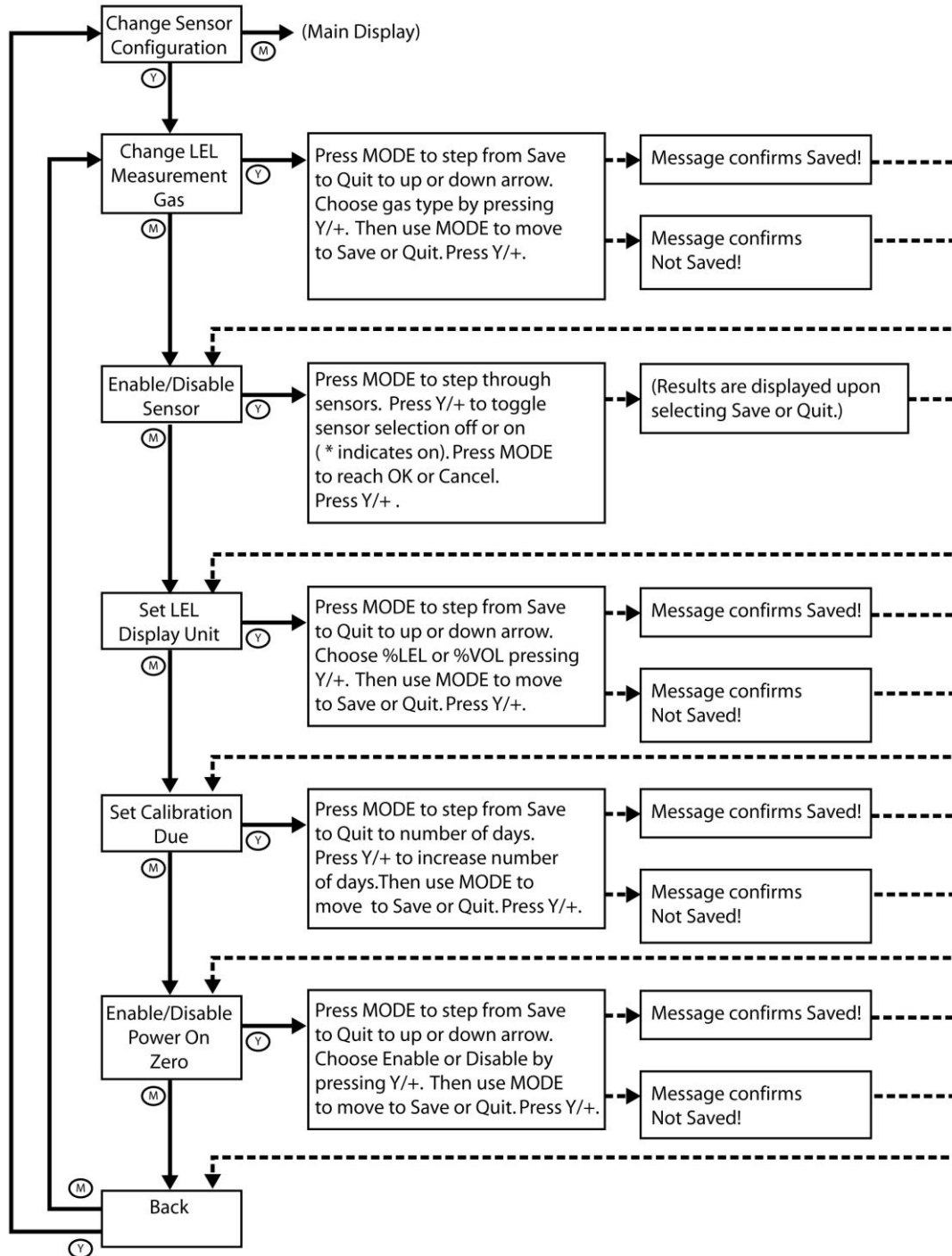

## QRAE II User Guide

**Change LEL Measurement Gas.** This function allows selection of the measurement gas for the LEL sensor. The correction for the measurement gas is automatically divided by the correction factor the span gas, selected previously, to obtain a new factor for the combination of gases. The new factor is applied to the readings to obtain a true concentration.

1. Press [MODE] until the up or down arrow is highlighted.
2. Press [Y+] to move through the list of LEL measurement gases.
3. Press [MODE] to select either the other arrow or to advance to Save or Quit.
4. With Save selected, press [Y/+] to save your settings, or [MODE] to advance to Quit (without saving settings).

If you choose to quit without saving the changes, press [Y/:]. You will see this message:

**Not Saved!**

If you want to make further changes to the settings, press [MODE] to repeat stepping through the choices.

**Enable/Disable Sensor.** This function allows you to selectively enable or disable individual sensors in the QRAE II. When a sensor is disabled, the unit does not datalog or display gas concentrations of that type.

1. Select a sensor to enable/disable by pressing [MODE] until the sensor's name is highlighted.
2. Press [Y/+] to toggle the selection on (indicated by an asterisk, \*) or off (no asterisk).

To select other sensors to calibrate, press [MODE] until you reach the sensor you want to select. Then press [Y/:].

After you have selected all the sensors you want enabled or disabled:

1. Press [MODE] to advance to Save or Cancel.
2. With Save selected, press [Y/+] to save your settings, or [MODE] to advance to Cancel (without saving settings).

**Set LEL Display Unit.** Choose from %LEL for percentage of lower explosive limit or %VOL for volume percent.

1. Press [MODE] to step from Save to Quit to the up or down arrow.
2. Choose %LEL or %VOL by pressing [Y/:].
3. Press [MODE] to step to Save or Quit.
4. Press [Y/+] to commit your change or to exit to the next menu item.

## QRAE II User Guide

**Set Calibration Due.** Set a Calibration Due day, which can create an alert during startup whenever a calibration must be performed.

1. Press [MODE] to step from Save and Quit and to advance through the digits.
2. Press [Y/+] to advance from 0 through 9. If you press [Y/+] when 9 is selected, it “wraps” around to 0 and begins counting up again each time you press [Y/+].
3. Press [MODE] to step to Save or Quit.
4. Press [Y/+] to commit your change or to exit to the next menu item.

**Enable/Disable Power On Zero.** This sets an optional step after the QRAE II starts up, pausing to ask whether you want to perform a zero (fresh air) calibration. After startup, the display says, “Fresh Air calibration?” The options are “OK” and “Cancel.” If you choose “OK,” you see “Calibration in progress...” This is followed by a countdown. At the end of the countdown, the display shows the four sensors, each followed by the word “Zeroed.” If you do not want a zero calibration, you can select “Cancel.”

1. Press [MODE] to step from Save to Quit to the up or down arrow.
2. Choose Enable or Disable by pressing [Y/+].
3. Press [MODE] to step to Save or Quit.
4. Press [Y/+] to commit your change or to exit to the next menu item.

**Back.** Press [MODE] to return to the top of the Change Sensor Configuration menu, or [Y/+] to exit the Change Sensor Configuration menu and return to the Programming Mode menu.

# QRAE II User Guide

## 5 Alarm Signal Summary

**Note:** Backlight automatically turns on when QRAE II alarms.

### Over Range

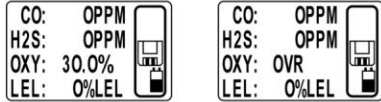

Over Range:  
Buzzer, LED: 3 times/second  
Vibrator: 400ms/second

### High Alarm

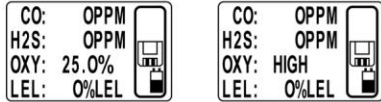

High Alarm:  
Buzzer, LED: 3 times/second  
Vibrator: 400ms/second

### Low Alarm

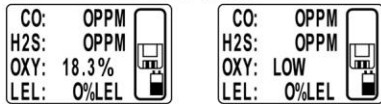

Low Alarm:  
Buzzer, LED: 2 times/second  
Vibrator: 400ms/second

### STEL Alarm



STEL Alarm:  
Buzzer, LED: 1 time/second  
Vibrator: 400ms/second

### TWA Alarm

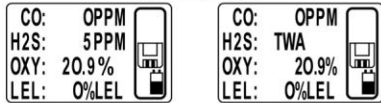

TWA Alarm:  
Buzzer, LED: 1 time/second  
Vibrator: 400ms/second

### Negative Drift



Negative Drift:  
Buzzer, LED: 1 time/second  
Vibrator: 400ms/second

### Calibration Failure

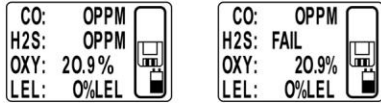

Calibration Failure:  
Buzzer, LED: 1 time/second  
Vibrator: 400ms/second

### Battery Low

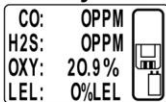

Battery Low:  
Buzzer, LED: 1 time/minute  
Vibrator: 400ms/minute

### Battery Dead

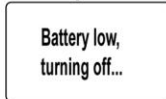

Battery Dead:  
LCD display "Battery low, turning off..."  
Unit turns off after 15 seconds

### Datalog Full

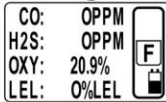

Datalog Full:  
Buzzer, LED: 1 time/second  
Vibrator: 400ms/second

### 6 Bump Testing & Calibrating The QRAE II

RAE Systems recommends that a bump test be performed on the QRAEII before the monitor is put into service, and later, prior to each use. A bump test is defined as a brief exposure of the monitor to the calibration gas and the sensors to show response and trigger the lowest alarm set point for each sensor.

- The QRAEII Multi Gas detector must be calibrated if it does not pass a Bump Test, or at least once every 180 days, depending on use and sensor exposure to poisons and contaminants.
- Calibration intervals and bump test procedures may vary due to national legislation.
- When using an H<sub>2</sub>S sensor in a QRAE II, RAE Systems recommends using RAE calibration gas cylinders with a 4 gas mix containing 10 ppm H<sub>2</sub>S, 50 ppm CO, 50% LEL Methane, and 18% Oxygen.

#### 6.1 Connecting the Calibration Gas To The Monitor (QRAE II Pump Model Only)

The QRAE II Pump must be calibrated using a fixed-flow regulator with a flow rate between 0.5 and 1.0 liters per minute.

1. Attach the hose from the regulator/calibration gas cylinder to the Calibration gas inlet on the front of the QRAE II Pump.
2. To calibrate, turn the gas flow on.

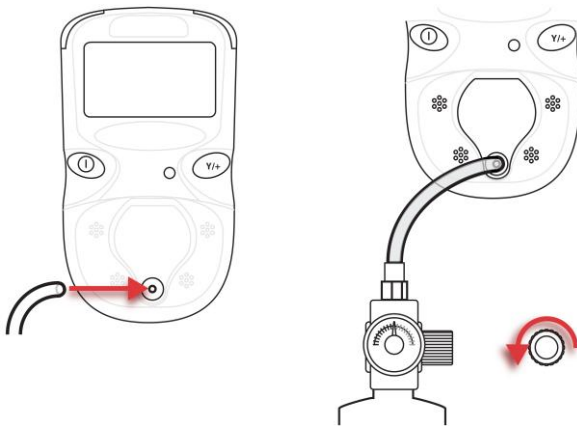

3. After calibration, turn off the gas and remove the hose from the QRAE II Pump.



## QRAE II User Guide

### 6.2 Connecting The Calibration Adapter (Diffusion Model Only)

The QRAE II is a diffusion monitor and must be calibrated using a fixed-flow regulator with a flow rate between 0.5 and 1.0 liters per minute. The QRAE II is supplied with a special calibration adapter that covers the gas diffusion ports.

1. Place the Calibration Adapter over the filter area on the front of the QRAE II.
2. Finger-tighten the screw at the center, as shown:

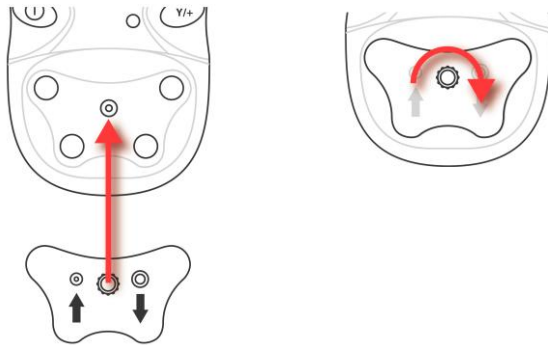

**Note:** Finger-tighten this only. Do not use pliers or other tools. The Calibration Adapter should be snug, but an air-tight seal is unnecessary.

3. Attach the hose from the regulator/calibration gas cylinder to the Calibration Adapter's inlet.

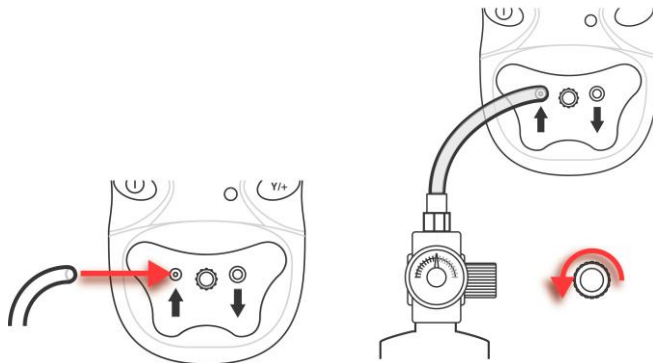

**Caution!** After calibration is complete, remove the Calibration Adapter. When monitoring, never operate the QRAE II with the Calibration Adapter attached. The QRAE II's sensors operate by diffusion. If the Calibration Adapter is attached during normal operation, inconsistent and lower-than-normal readings will occur because of decreased concentration of the gas being monitored.

## QRAE II User Guide

### 6.3 Disconnecting The Calibration Adapter (Diffusion Model Only)

After calibrating the QRAE II, you must remove the Calibration Adapter.

#### Sensor Calibration Time

The QRAE II is designed to automatically use a predetermined calibration time. Never operate the QRAE II with the Calibration Adapter attached

To disconnect the Calibration Adapter:

1. Loosen the finger-screw at the center of the Calibration Adapter.

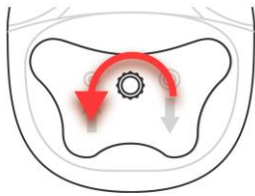

2. Lift the Calibration Adapter from the QRAE II and store it.

#### **WARNING!**

All newly purchased RAE Systems instruments should be bump tested by exposing the sensor(s) to known concentrations of calibration gas.

The monitor should be calibrated if it does not pass a bump test, but no less than every 6 months, depending on use and exposure to gas and contamination, and its operational mode.

Bump test is defined as an exposure to gas that triggers the lowest alarm.

## QRAE II User Guide

### 6.4 Zero (Fresh Air) Calibration

This procedure determines the zero point of the sensor calibration curve. Expose the inlet to a clean air source with 20.9% oxygen and without any organic, toxic or combustible gas impurities. This “Zero Air” can be from a cylinder, clean ambient air, or ambient air purified through a charcoal filter.

#### 6.4.1 Using Fresh Air

**Caution!** If your QRAE II is a diffusion model, do not use the Calibration Adapter while performing zero calibration in fresh air.

Turn on the QRAE II and follow this procedure:

1. Enter Program Mode.
2. At Calibrate Monitor, press [Y/+].

You should see:

**Fresh Air Calibration?**

3. Press Y+ to start calibration. Calibration is performed automatically.

#### 6.4.2 Using Zero Gas

1. Attach the Calibration Adapter to the QRAE II (diffusion model only).
2. Attach the regulator to the Zero Gas cylinder.
3. If your model is a QRAE II diffusion model, attach a hose to the Calibration Adapter and to the regulator. If it is a QRAE II Pump model, attach a hose to the regulator and to the inlet on the front of the QRAE II Pump.
4. Enter the Password.
5. At Calibrate Monitor, press [Y/+].
6. When you see “Fresh Air Calibration?” turn on the regulator to start the Zero Gas flow.
7. Press [Y/+].

You should see a countdown from 30 seconds:

**Calibration  
in progress ... 30**

## QRAE II User Guide

When calibration is complete, you will see the screen change between these two:

<b>CO: Zeroed</b>		<b>CO: 0ppm</b>
<b>H2S: Zeroed</b>	<b>and</b>	<b>H2S: 0ppm</b>
<b>OXY: Zeroed</b>		<b>OXY: 20.9%</b>
<b>LEL: Zeroed</b>		<b>LEL: 0%LEL</b>

When the zero calibration is successful, the display should show a reading of “20.9” for the oxygen sensor and “0” for all other sensors.

### 6.5 Multiple Sensor Calibration

This function simultaneously determines the second point of the calibration curve for multiple sensors in the monitor. The display counts down from 60 to 0 seconds, and then shows the name of each sensor, whether it passed or failed calibration, and the calibrated value for each sensor.

Select a sensor to calibrate by pressing [MODE] until the sensor’s name is highlighted. Then press [Y/+] to toggle the selection on (indicated by an asterisk, \*) or off (no asterisk). To select other sensors to calibrate, press [MODE] until you reach the sensor you want to select. Then press [Y/+].

After you have selected all the sensors you want calibrated, it is time to perform the calibration.

1. Attach the Calibration Adapter to the QRAE II (diffusion model only).
2. Attach the regulator to the calibration gas cylinder.
3. If your model is a QRAE II diffusion model, attach a hose to the Calibration Adapter and to the regulator. If it is a QRAE II Pump model, attach a hose to the regulator and to the inlet on the front of the QRAE II Pump.
4. Turn on the regulator to start the Calibration Gas flow.
5. Press [MODE] until OK is highlighted.
6. Press [Y/+] to start calibration.

You should see a countdown from 60 seconds:

**Calibration  
in progress ... 60**

**Note:** If you see the following message, check that the gas is flowing and the hose is attached:

**No Gas Flow... Apply gas or hit any key to start.**

## QRAE II User Guide

When calibration is complete, you will see the screen change between these two:

**Multiple Sensor Calibrated!**

and

**CO = Pass**  
**H2S = Pass**  
**O2 = Pass**  
**LEL = Pass**

A sensor calibration failure is indicated like this:

**CO = Fail**  
**H2S = Pass**  
**O2 = Pass**  
**LEL = Pass**

If a sensor fails, try calibrating again. If calibration fails again, replace the sensor.

### 6.6 Single Sensor Calibration

This procedure determines the second point of the sensor calibration curve for a single sensor. The display counts down from 60 to 0 seconds, and then shows the name of each sensor, whether it passed or failed calibration, and the calibrated value for each sensor.

Select the sensor to calibrate by pressing [MODE] until the sensor's name is highlighted. Then press [Y/+] to toggle the selection on (indicated by an asterisk, \*) or off (no asterisk).

After you have selected the sensor you want calibrated, it is time to perform the calibration.

1. Attach the Calibration Adapter to the QRAE II (diffusion model only).
2. Attach the regulator to the Calibration Gas cylinder.

**Important!** Make sure you have the correct calibration gas in the correct concentration. Also make sure that the calibration gas is not beyond its "Best when used by" date, which is stamped on the cylinder's label.

3. If your model is a QRAE II diffusion model, attach a hose to the Calibration Adapter and to the regulator. If it is a QRAE II Pump model, attach a hose to the regulator and to the inlet on the front of the QRAE II Pump.
4. Turn on the regulator to start the Calibration Gas flow.
5. Press [MODE] until OK is highlighted.
6. Press [Y/+] to start calibration.

## QRAE II User Guide

You should see a countdown from 60 seconds:

**Calibration  
in progress ... 60**

**Note:** If you see the following message, check that the gas is flowing and the hose is attached:

**No Gas Flow... Apply gas or hit any key to start.**

When calibration is complete, you will see the screen change. If the sensor calibration passes, then you should see this message (shown here for carbon monoxide, CO):

**CO calibration pass!**

If the sensor calibration fails, try calibrating again. If calibration fails again, replace the sensor.

# QRAE II User Guide

## 7 Connecting To A Computer

Downloading datalog data to computer requires placing the QRAE II in its cradle and connecting the cradle to a computer.

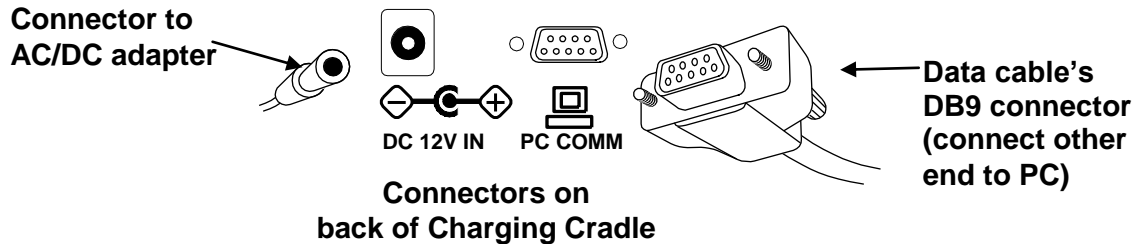

The QRAE II's cradle connects via a DB9 (9-pin) connector to a computer running ProRAE Remote software.

Press the DB9 connector into the DB9 serial port on the cradle, and then finger-tighten the two screws on the connector. These keep the connector from coming loose and ensure the best electrical connection. Make sure the AC/DC adapter is connected to the cradle, as well, to power the QRAE II and keep its battery from draining.

**Note:** If your computer has a USB port instead of a DB9 connector, use a USB to 9-pin serial adapter (part number 410-0210-000).

## 8 Transferring Data To & From A Computer

Once you have connected your QRAE II cradle to the PC, you can transfer data, including a download of the datalog to the computer and updates of firmware to the QRAE II (should this ever be necessary).

### 8.1 Downloading The Datalog To A PC

1. Connect the data cable to the PC and the cradle.
2. Place the QRAE II into its cradle. The charging LED should be illuminated.
3. Start ProRAE Studio on your PC.
4. From ProRAE Studio, select "Operation" and select Setup Connection.
5. Select the COM port to establish a communication link between the PC and the QRAE II.
6. To receive the datalog in the PC, select "Downlog Datalog."
7. When you see "Unit Information," click OK.

The download process typically takes less than 10 seconds. During the data transfer, the display shows a progress bar.

## QRAE II User Guide

When the transfer is done, you will see a screen with the datalog information. You can now export this datalog for other use or printing.

### 8.2 Uploading Firmware To The QRAE II From A PC

Uploading new firmware to your QRAE II requires connecting the QRAE II and PC. Follow these steps to make the connection:

1. Connect the data cable to the PC and the cradle.
2. Place the QRAE II into its cradle. The charging LED should be illuminated.
3. Start ProRAE Studio on your PC.
4. From ProRAE Studio, select “Operation” and select Setup Connection.
5. Select the COM port to establish a communication link between the PC and the QRAE II.

Once communication is established, follow the instructions that accompany ProRAE Studio and the firmware to upload the new firmware to your QRAE II.



## 9 Maintenance



Maintenance should be performed only by a qualified person who has proper training and fully understands the contents of this manual.

The following guidelines should be followed when changing components:

1. Turn off the unit and unplug the charger before changing a battery.
2. When changing a sensor, detach the battery first. Identify the location of a specific sensor and pay attention to the sensor pin orientation when removing and plugging in sensors.

### WARNING

To reduce the risk of ignition of hazardous atmospheres, recharge battery only in area known to be non-hazardous. Remove and replace battery only in an area known to be non-hazardous.

### 9.1 Replacing the QRAE II Li-Ion Battery

**Caution:** Turn off the QRAE II before removing or replacing the battery.

1. Place the QRAE II face-down on a soft surface.
2. Use the hex wrench to loosen each of the three screws by turning them counterclockwise.

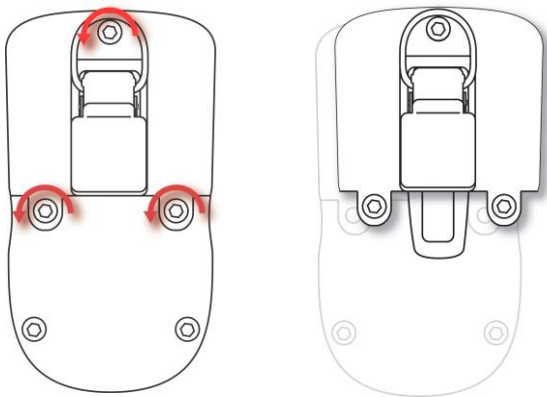

3. Hold the QRAE II down and lift the compartment cover by pulling on the belt clip.

## QRAE II User Guide

4. Turn the QRAE over and slide the battery out of its compartment.

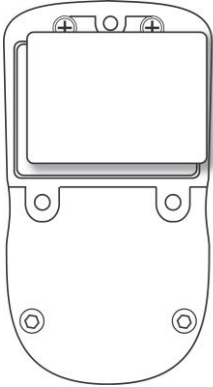

5. Place the new battery into the compartment with its six gold-plated contacts aligned over the six pins.

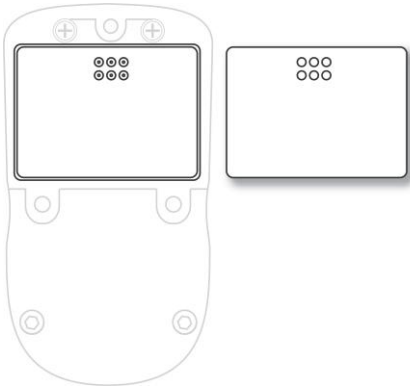

**Note:** Before installing the new battery, visually inspect the contacts to make sure they are clean. If they are not, wipe them with a soft cloth. Do not use solvents or cleaners.

6. Place the cover over the compartment.
7. Tighten all three screws by turning them clockwise with the hex wrench.

### 9.2 Installing The Alkaline Battery Adapter

The Alkaline Battery Adapter substitutes for the Li-Ion battery. The adapter (part number 020-3403-000) accepts three AA alkaline batteries (use only Duracell MN1500) to provide approximately 12 hours of operation.

2. Place the QRAE II face-down on a soft surface.
3. Use the hex wrench to loosen each of the three screws by turning them counterclockwise.
4. Hold the QRAE II down and lift the compartment cover by pulling on the belt clip.
5. Turn the QRAE over and slide the Li-ion battery out of its compartment.

## QRAE II User Guide

6. Install three AA alkaline batteries into the Alkaline Battery Adapter, making sure the battery polarity is correct.
7. Place the Alkaline Battery Adapter into the compartment with its six gold-plated contacts aligned over the six pins.
8. Place the cover over the compartment.
9. Tighten all three screws by turning them clockwise with the hex wrench.
10. The monitor automatically detects the alkaline batteries.

### IMPORTANT!

Alkaline batteries cannot be recharged. The QRAE II's internal circuit detects alkaline batteries and will not allow recharging. If you place the QRAE II in its cradle, the alkaline battery will not be recharged, and you will see this icon:



**Note:** When replacing alkaline batteries, dispose of old ones properly.

### WARNING!

To reduce the risk of ignition of hazardous atmospheres, recharge the battery only in areas known to be non-hazardous. Remove and replace the battery only in areas known to be non-hazardous.

## 9.3 Charging A Spare QRAE II Li-Ion Battery

A QRAE II Li-ion battery can be charged when it is not inside the QRAE II. The charging cradle is designed to accommodate both types of charging. Contacts on the bottom of the QRAE II battery meet the contacts on the cradle, transferring power without other connections, and two clips hold the battery in place during charging.

1. Plug the AC/DC adapter into the QRAE II's cradle.
2. Place the battery into the cradle, with the six gold-plated contacts on top of the six matching charging pins.
3. Plug the AC/DC adapter into the wall outlet.

The QRAE II battery begins charging automatically. During charging, the LED in the cradle glows red. When charging is complete, it glows green.

Release the battery from the cradle by pressing the keys on both sides of the cradle and lifting the battery out of its slot.

**Note:** If you need to replace the 3.7V Li-ion battery pack, replacements are available from RAE Systems. The part number is 020-3402-000.

## QRAE II User Guide

### 9.4 Replacing Sensors

Under normal operating conditions, sensors lose their original sensitivity after the expected operating life and need to be replaced.

**Warranties:** The oxygen (O<sub>2</sub>), combustible gas (LEL), hydrogen sulfide (H<sub>2</sub>S) and carbon monoxide (CO) sensors all have a 2-year warranty.

Replace a sensor when it fails to calibrate. If it fails to calibrate, retry calibrating it. Check the QRAE II's parameter settings, and check that the calibration gas is not beyond its "Use by" date. For further details, refer to RAE Systems Technical Note TN-123, "Special Diagnostic Modes For RAE Systems Instruments," available at [www.raesystems.com](http://www.raesystems.com).

When a CO or H<sub>2</sub>S sensor is saturated, the LCD gives you this message:

**Xxx Fail**  
**Turn off unit**  
**Remove or**  
**Replace sensor**

Turn off the QRAE II and replace the sensor. Always recalibrate after replacing a sensor.

If the LEL sensor fails, the LCD indicates it like this:

**CO: 0ppm**  
**H2S: 0.0ppm**  
**OXY: 20.9%**  
**LEL: Fail**

Instead of showing a reading, the word "Fail" appears. Replace the LEL sensor and recalibrate the instrument.

If the oxygen sensor fails, there is no prompt. If you install a bad oxygen sensor, the QRAE II gives a message of "Oxy not found" during startup diagnostics.

#### 9.4.1 Sensor Locations

The sensors are located inside the front of the monitor.

See RAE Systems Technical Note TN-114, Sensor Specifications And Cross-Sensitivities, for additional information, available at [www.raesystems.com](http://www.raesystems.com).

#### To replace a sensor:

1. Turn off the QRAE II.
2. Place the QRAE II face-down on a soft surface.

## QRAE II User Guide

3. Remove the front sensor cover by loosening the two screws on the back of the monitor below the battery cover. Use the supplied hex wrench.

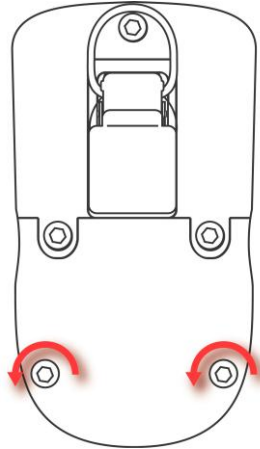

4. Push the screws from the back of the monitor to pop the cover off the front.
5. Locate the sensor you need to replace.

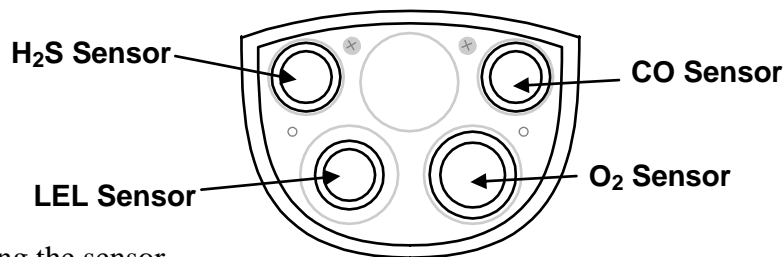

6. Using the sensor puller, carefully remove the sensor by pulling it straight out.
7. Replace the sensor with a new one. Make sure the pins are not bent or corroded. Align the pins to the corresponding holes and push straight in. Do not push on the middle of the sensor with your finger, as this may damage it. The sensor should fit flush against the printed circuit board.

**Note:** Each sensor socket is labeled to guide you in placing the correct sensor into it. If a sensor does not seem to fit, examine it to ensure that it is the correct sensor, the pins are not bent, and that the pins are aligned to the holes.

8. Press the sensors all the way into the socket.

**Important!** Sensors are not interchangeable. Use only RAE Systems sensors, and use only the sensor type specified for your QRAE II monitor. Use of non-RAE Systems components will void the warranty and can compromise the safe performance of this product.

9. Inspect the internal filter (QRAE II diffusion model only). If it is dirty, discolored, or wet, replace it. See Replacing The Filter, below.

## QRAE II User Guide

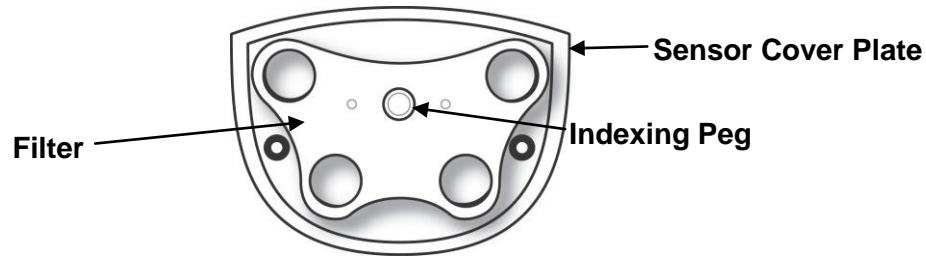

10. Place the filter onto the inside of the sensor cover. Make sure it is aligned properly by matching its center hole with the indexing peg at the middle of the cover.
11. Replace the sensor cover. Hold the cover against the QRAE II and place the QRAE II on a soft surface. Use the hex wrench to tighten the two screws. Do not overtighten them.
12. Turn the monitor on and the newly installed sensors should be properly identified by the EntryRAE in the start-up screen. Let the monitor run for 15 minutes before calibration.
13. Calibrate all sensors prior to using the QRAE II.

### 9.5 Replacing The Filter

The filter is made of PTFE (Teflon<sup>®</sup>) membrane designed to prevent water and dust from entering the sensors. The filter should be replaced if it changes color, traps dust or other particulates, or if it has been saturated with water or other liquids. On the diffusion model, only use the filter with part number 020-2419-000. For the pumped model, use the filter with part number 008-3022-010 (sold in packages of 10 only).

### 9.6 Replacing The Pump (QRAE II Pump Model Only)

If the pump requires replacement, only use an exact replacement from RAE Systems, part number 020-3603-000-FRU. Only replace the pump in a safe area, and always set the stall speed and recalibrate the QRAE II before placing it back into service.

#### To replace the pump:

1. Turn off the QRAE II.
2. Place the QRAE II face-down on a soft surface.
3. Remove the front sensor cover by loosening the two screws on the back of the monitor below the battery cover. Use the supplied hex wrench.

## QRAE II User Guide

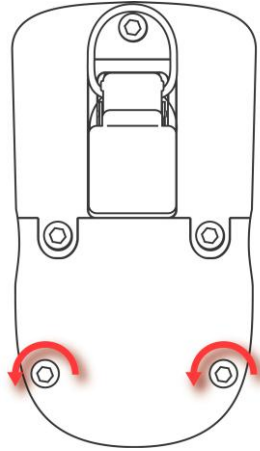

4. Push the screws from the back of the monitor to pop the cover off the front.



## QRAE II User Guide

5. Turn over the cover and pull off the plate with the pump attached.

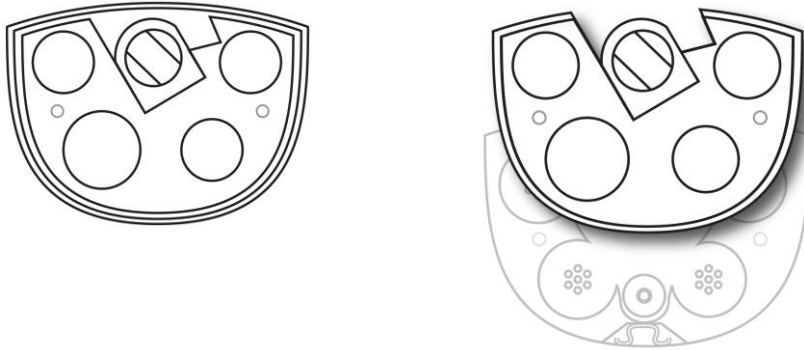

6. Turn over the plate holding the pump, and lift the pump off.

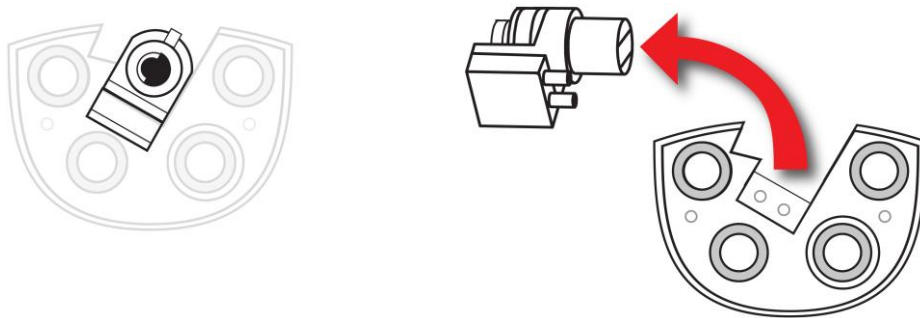

7. Replace the pump by pressing the new pump firmly into its recessed area on the plate.

**Note:** The O-rings must be mounted on the plate, and not the pump.

8. Press the plate back into the rear of the cover.
9. Set the cover back onto the front of the QRAE II Pump, and press it into place.
10. Turn over the QRAE II Pump, and tighten the two screws to hold the cover. Do not overtighten the screws.

### 9.7 Cleaning

Occasional cleaning with a soft cloth is recommended. Do not use detergents or chemicals. Do not submerge the QRAE II or place it under running water. If necessary, you can use a damp cloth (water only). For the diffusion model, it is a good idea to install the Calibration Adapter before cleaning the QRAE II's housing, to keep dirt, dust, or moisture away from the sensor openings and to keep the filter clean.

Visually inspect the contacts at the base of the QRAE II, on the battery, and on the Charging cradle to make sure they are clean. If they are not, wipe them with a soft, dry cloth. Never use solvents or cleaners.



## QRAE II User Guide

### 9.8 Firmware Updates

Firmware is occasionally updated for RAE Systems products. Check the RAE Systems website for updates:

<http://www.raesystems.com>

### 9.9 Ordering Replacement Parts

If you need replacement parts, contact your local RAE Systems distributor. A list is available online:

<http://www.raesystems.com>

In the U.S., you can order sensors, replacement batteries, and other accessories online at:

<http://istore.raesystems.com/>

### 9.10 Electronic Waste Disposal



This symbol (crossed-out wheeled bin) indicates separate collection of waste electrical and electronic equipment in the EU countries.

This product may contain one or more Nickel-metal hydride (NiMH), Lithium-ion, or Alkaline batteries. Specific battery information is given in this user guide.

Batteries must be recycled or disposed of properly.

At the end of its life, this product must undergo separate collection and recycling from general or household waste. Please use the return and collection system available in your country for the disposal of this product.

### 9.11 Year of Manufacture

To identify the year of manufacture, refer to the serial number of the instrument.

The second to last digit in the serial number indicates the year of manufacture. For example, “N” indicates the manufacturing year is 2011.

First digit	Year
N	2011
P	2012
Q	2013
R	2014
S	2015
T	2016
U	2017
V	2018
W	2019

## QRAE II User's Guide

### 10 Troubleshooting

<b>Problem</b>	<b>Possible Reasons &amp; Solutions</b>
Cannot turn on power after charging the battery	<p><b>Reasons:</b> Discharged battery. Defective battery.</p> <p><b>Solutions:</b> Charge or replace battery.</p>
No LCD back light	<p><b>Reasons:</b> Trigger level too low, the current mode is not user mode, and the mode does not support automatic turn on back light.</p> <p><b>Solutions:</b> Adjust trigger level. Verify the back light can be turned on. Verify that the backlight is not in manual mode. Call authorized service center.</p>
Lost password	<p><b>Solutions:</b> Call Technical Support at +1 408-752-0723 or toll-free at +1 888-723-4800</p>
Reading abnormally Low	<p><b>Reasons:</b> Dirty filter. Calibration Adapter is attached. Incorrect calibration.</p> <p><b>Solutions:</b> Replace filter. Remove Calibration Adapter. Calibrate the QRAE II.</p>
Buzzer Inoperative	<p><b>Reasons:</b> Bad buzzer.</p> <p><b>Solutions:</b> Check that buzzer is not turned off. Call authorized service center.</p>
Pump stalls too easily or not at all (QRAE II Pump only)	<p><b>Reasons:</b> Stall set incorrectly. Pump damaged.</p> <p><b>Solutions:</b> Adjust stall values. Replace pump and recalibrate monitor.</p>

### 11 Technical Support

To contact RAE Systems Technical Support Team:

Monday through Friday, 7:00AM to 5:00PM Pacific (US) Time

Phone (toll-free): +1 888-723-4800

Phone: +1 408-952-8461

Email: [tech@raesystems.com](mailto:tech@raesystems.com)

Life-critical after-hours support is available:

+1 408-952-8200 select option 8

## 12 RAE Systems Contacts

### **RAE Systems**

#### **World Headquarters**

3775 N. First St.

San Jose, CA 95134-1708 USA

Phone: +1 408.952.8200

Fax: +1 408.952.8480

**E-mail:** [customerserv@raesystems.com](mailto:customerserv@raesystems.com)

**Web Site:** [www.raesystems.com](http://www.raesystems.com)

### **RAE Systems Technical Support**

Monday through Friday, 7:00AM to 5:00PM Pacific Time

Phone: +1.408.952.8461

Email: [tech@raesystems.com](mailto:tech@raesystems.com)

Life-critical after-hours support is available

+1.408.952.8200 select option 8

### **RAE Systems Europe ApS**

Kristinehøj 23 A

DK-2770 Kastrup

Denmark

**Phone:** +45 86 52 51 55

**Fax:** +45 86 52 51 77

[orders@raeeurope.com](mailto:orders@raeeurope.com)

[sales@raeeurope.com](mailto:sales@raeeurope.com)

[service@raesystems.com](mailto:service@raesystems.com)

**Web:** [www.raesystems.eu](http://www.raesystems.eu)

### **RAE Systems UK Ltd**

D5 Culham Innovation Centre

Culham Science Centre

Abingdon, Oxon OX14 3DB

United Kingdom

**Phone:** +44 1865408368

**Fax:** +44 1235531119

**Mobile:** +44 7841362693

**Email:** [raeuk@raeeurope.com](mailto:raeuk@raeeurope.com)

## QRAE II User's Guide

### **RAE Systems France**

ZI des Ayats  
679390 MILLERY  
France  
**Phone:** +33 4 78 46 16 65  
**Fax:** +33 4 78 46 25 98  
**Email:** info-france@raeeurope.com  
**Web:** www.raesystems.fr

### **RAE BeNeLux BV**

Hoofdweg 34C  
2908 LC Capelle a/d IJssel  
The Netherlands  
**Phone:** +31 10 4426149  
**Fax:** +31 10 4426148  
**Email:** info@rae.nl  
**Web:** www.rae.nl

### **RAE Systems Spain, s.l.**

Av. Remolar, 31  
08820 El Prat de Llobregat  
Spain  
**Phone:** +34 933 788 352  
**Fax:** +34 933 788 353  
**Mobile:** +34 687 491 106  
**Email:** spainsales@raesystems.com  
**Web:** www.raespain.com

### **RAE Systems Middle East**

**Mobile:** +45 2674 9791  
or +97 50 429 1385  
**Email:** mesales@raesystems.com

### **RAE Systems Germany GmbH**

Felix-Wankel-Str. 5  
82152 Krailing  
Germany  
**Phone:** +49 89 20 70 40 248  
**Fax:** +49 89 850 93 74  
**Email:** orders@raeeurope.com

### **RAE Systems (Hong Kong) Ltd.**

Room 8, 6/F, Hong Leong Plaza  
33 Lok Yip Road  
Fanling, N.T, Hong Kong  
**Phone:** +852.2669.0828  
**Fax:** +852.2669.0803  
**Email:** hksales@raesystems.com

### **RAE Systems Japan**

403 Plaza Ochanomizu Bldg. 2-1  
Surugadai Kanda Chiyoda-Ku  
Tokyo, Japan  
**Phone:** 81-3-5283-3268  
**Fax:** 81-3-5283-3275  
**Email:** jpsales@raesystems.com

### **RAE Systems Korea**

#1010, DaeMyungAnsVill First,  
Sang-Dong 412-2, Wonmi-Gu, Bucheon,  
Kyungki-Do, Korea  
**Phone:** 82-32-328-7123  
**Fax:** 82-32-328-7127  
**Email:** krsales@raesystems.com

# QRAE II User's Guide

## 13 Controlled Part of Manual

The model PGM 2400 and PGM 2400P are certified according to the IECEx scheme, ATEX and cCSAus (for U.S. and Canada). PGM 2400P is intrinsically safe and may be used in hazardous locations.

SUBSTITUTION OF COMPONENTS MAY IMPAIR INTRINSIC SAFETY.

### 13.1 Marking

The product is marked with the following information:

RAE SYSTEMS  
3775 N. 1<sup>st</sup>. St., San Jose  
CA 95134, USA

TYPE PGM 2400 or PGM 2400P  
Serial No/matrix: XXX-XXXX-000

IECEX CSA 07.0007X Ex d ia IIC T4 Gb	CE 0575 SIRA 12 ATEX 2156 Ex II 2G Ex ia d IIC T4	 c <sub>US</sub> Int. Safe CI I, Dv 1 Gr. A, B, C, D, T4 C22.2 No 152-1984 ISA-12.13.01-2000
---	---	--

Warning: Use only 020-3402-000 or 020-3403-000 battery pack. Do not change batteries in hazardous location. Do not mix old/new or different type of batteries. Understand the manual before operating.

**EM Immunity:** No effect when exposed to 0.43mW/cm<sup>2</sup> RF interference (5-watt transmitter at 12"/10cm).

**Temperature:** -20° C ≤ Tamb ≤ +50° C

**Humidity:** 0% to 95% relative humidity (non-condensing)

**Warnings:** Use only 020-3402-000 or 020-3403-000 battery pack.  
Do not change batteries in hazardous locations.  
Do not mix old/new or different types of batteries.  
Understand the manual before operating.

## QRAE II User's Guide

### Hazardous Areas classified by Zones

PGM 2400 and PGM 2400P are intended to be used in hazardous areas classified for zone 1 or zone 2, within the temperature range of -20° C to +50° C, where gases of explosion groups IIA, IIB or IIC and T4 may be present.

### Hazardous Areas classified by Divisions

PGM 2400 and PGM 2400P are intended to be used in hazardous areas classified for Class I Div. 1 or 2, within the temperature range of -20° C to +50° C, where gases of explosion groups A, B, C or D and temperature class T4 may be present.

#### Caution:

Refer to RAE Systems Technical Note TN-114 for sensor cross-sensitivities.

Refer to RAE Systems Technical Note TN-144 for LEL sensor poisoning.

**Caution: Before each day's usage, sensitivity must be tested on a known concentration of methane gas equivalent to 20-50% of full scale concentration. Accuracy must be within 0-20% of actual. Accuracy may be corrected by calibration procedure.**

**Attention: Avant chaque utilisation journaliere verifier la sensibilite avec une concentration connue de methane equivalente a 20-50% de la pleine echelle. La precision doit etre comprise entre 0-20% de la valeur vraie et peut etre corrigee par une procedure de recalibrage.**

The model PGM-2400 and PGM-2400P are certified according to the IECEx scheme, ATEX and cCSAus (for U.S. and Canada). PGM2400P is intrinsically safe and may be used in hazardous locations.

SUBSTITUTION OF COMPONENTS MAY IMPAIR INTRINSIC SAFETY.

**Note:** Users are recommended to refer to ISA -RP12.13, Part II-1987 for general information on installation, operation, and maintenance of combustible gas detection instruments

• **Only the combustible gas detection portion of this instrument has been assessed for performance.**

**Uniquement, la portion pour detector les gaz combustibles de cet instrument a été évalué.**

• **Any rapid up-scale reading followed by a declining or erratic reading may indicate a gas concentration beyond upper scale limit which may be hazardous.**

**Toute lecture rapide et positive, suivie d'une baisse subite au erratique de la valeur, peut indiquer une concentration de gaz hors gamme de détection qui peut être dangereuse.**

• The QRAEII Multi Gas detector must be calibrated if it does not pass a Bump Test, or at least once every 180 days, depending on use and sensor exposure to

## QRAE II User's Guide

poisons and contaminants.

**Range, Resolution & Response Time (LEL):** 0% - 100%, 1%, 15 sec.



# QRAE II User's Guide

## Basic Operation

### Turning The QRAE II On

To turn the QRAE II on, hold down [MODE] for 2 seconds.

**Caution:** The alarm is very loud. During startup, you can mute most of the sound by holding a finger over the alarm port.

**Note:** Do not put tape over the alarm port to permanently mute it.

When starting up, the QRAE II simultaneously turns the backlight on and off, beeps once, blinks once, and vibrates. The screen shows:

**On...**

**RAE Systems Inc.  
QRAE II  
(Language)**

This is followed by a progression of screens that tell you the QRAE II's current settings:

- Firmware version number and serial number
- List of installed sensors
- Last Calibration date and time
- Alarm Limits (High, Low, STEL, TWA)
- Today's date, the current time, and the current temperature
- Alarm Mode, battery voltage, shutoff voltage
- Datalog Mode
- Datalog Period
- Datalog Time Left

The QRAE performs a final checkout and the screen shows a countdown to full operational functionality.

If Datalog is on, this message is displayed after the countdown:

**Datalog Started**

## QRAE II User's Guide

When the QRAE II is ready for use, it shows this screen:

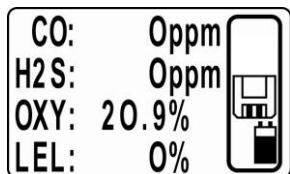

**Note:** If datalogging is off, you will not see the datalogging icon (see icons, page 10).

### Inverting The Display

The QRAE II is easy to read, whether held in the hand or clipped to a belt. To flip the screen, press the [Y/+] key and hold it down for 3 seconds. When the image inverts, release the key.

### Testing The Alarms (Anytime)

Under normal non-alarm conditions, the buzzer, vibration alarm, LED, and backlight can be tested at any time by pressing [Y/+] once.

### Turning The QRAE II Off

Press and hold [MODE]. In 2 seconds, a 5-second countdown to shutoff begins. You must hold your finger on the key for the entire shutoff process. If you remove your finger from the key during the countdown, the shutoff operation is canceled and the QRAE II continues normal operation.

The countdown proceeds as follows, accompanied at each step with an alarm beep and light flash. The display shows the countdown in sequence:

**Unit off in 5 seconds...**  
**Unit off in 4 seconds...**  
**Unit off in 3 seconds...**  
**Unit off in 2 seconds...**  
**Unit off in 1 seconds...**  
**Unit off in 0 seconds...**  
**Unit off...**

When you see "Unit off..." release your finger from the [MODE] key. The QRAE II is now off.

**Caution:** The alarm is very loud. During shutdown, you can mute most of the sound by holding a finger over the alarm port.

# QRAE II User's Guide

## Programming Mode

Programming Mode can be entered from Normal Mode or Diagnostic Mode. This mode contains most adjustable settings for the QRAE II. It is organized into five submenus:

- Calibrate Monitor
- Change Alarm Limits
- Change Datalog
- Change Monitor Setup
- Change Sensor Configuration

The following diagram shows how to enter Programming Mode from Normal Mode and from Diagnostic Mode:

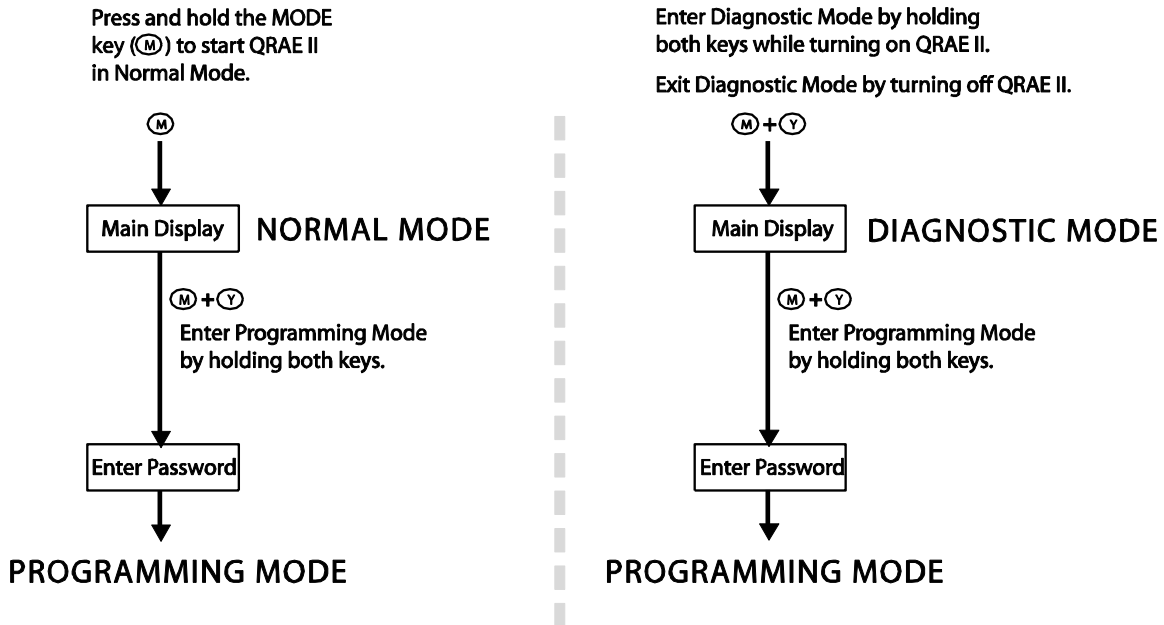

**Modify Span Gas Value.** This function allows selection of the gas concentration for each sensor.

**Setting the span value separately for each sensor.**

1. Select a sensor by pressing [MODE] until the sensor's name is highlighted.
2. Press [MODE] to advance through the digits on each sensor.
3. Press [Y/+] to increase the number (0 to 9).

**Note:** Once the number reaches 9, pressing [Y/+] returns to 0 and starts counting up again each time [Y/+] is pressed.

4. Press and hold [MODE] for 3 seconds and release to advance to the next sensor.

## QRAE II User's Guide

5. After you have set all of the span values, hold [MODE] for 3 seconds and release. Save is highlighted.
6. Press [Y/+] to save your settings, or [MODE] to advance to Quit (without saving settings).

If you choose to quit without saving the changes, press [Y/:]. You will see this message:

**Not Saved!**

If you want to make further changes to the settings, press [MODE] to repeat stepping through the sensors.

**Change LEL Span Gas.** This function allows selection of the gas to be used for span calibration of the LEL sensor. The correction for the measurement gas is automatically divided by the correction factor the span gas, selected previously, to obtain a new factor for the combination of gases. The new factor is applied to the readings to obtain a true concentration.

1. Press [MODE] until the up or down arrow is highlighted.
2. Press [Y/+] to move through the list of LEL span gases.
3. Press [MODE] to select either the other arrow or to advance to Save or Quit.
4. With Save selected, press [Y/+] to save your settings, or [MODE] to advance to Quit (without saving settings).

If you choose to quit without saving the changes, press [Y/:]. You will see this message:

**Not Saved!**

If you want to make further changes to the settings, press [MODE] to repeat stepping through the choices.

**Back.** Press [MODE] to return to the top of the Calibrate Monitor menu, or press [Y/+] to return to the top of the Normal Mode menu.

### Change Alarm Limits

The high and low alarm limits, as well as the points at which the STEL and TWA alarms are triggered, can be modified in this set of menus. Each sensor's limits for each of these can be set separately, providing extremely precise alarm thresholds.

**Alarm Signals.** During each measurement period, the gas concentration is compared with the programmed alarm limits (gas concentration alarm limit settings: Low, High, TWA and STEL). If the concentration exceeds any of the preset limits, the loud buzzer, red flashing LED, and vibration alarm are activated immediately to warn of the alarm condition. In addition, the QRAE II alarms if one of the following conditions occurs: battery voltage falls below a preset voltage level, or when the datalog memory is full. When the low battery alarm occurs, there will be approximately 20 to 30 minutes of

## QRAE II User's Guide

operating time remaining. When the battery voltage falls below the low threshold, the QRAE II turns off automatically.

Submenus in this section are:

- High Alarm Limit
- Low Alarm Limit
- Stel Alarm Limit
- Average Alarm Limit

**Change Alarm Mode.** Your choices are Auto Reset and Latched. A latched alarm stays in alarm until you acknowledge the alarm by pressing a button. An auto-reset alarm turns off when the condition that set off the alarm is no longer present (for instance, a high H<sub>2</sub>S reading that exceeds the preset threshold and triggers an alarm, but then lowers below that threshold, turning the alarm off).

1. Press [MODE] to step from Save to Quit to the up or down arrow.
2. Choose Auto Reset or Latched by pressing [Y/+].
3. Press [MODE] to step to Save or Quit.

Press [Y/+] to commit your change or to exit to the next menu item.

---

## Bump Testing & Calibrating QRAE II (Pump Version)

RAE Systems recommends that a bump test be performed on the QRAEII before the monitor is put into service, and later, prior to each use. A bump test is defined as a brief exposure of the monitor to the calibration gas and the sensors to show response and trigger the lowest alarm set point for each sensor.

- The QRAEII Multi Gas detector must be calibrated if it does not pass a Bump Test, or at least once every 180 days, depending on use and sensor exposure to poisons and contaminants.
- Calibration intervals and bump test procedures may vary due to national legislation.

**Note:** Bump test and calibration can also be performed by using the RAE Systems AutoRAE Lite For QRAE II docking station.

# QRAE II User's Guide

## Connecting Calibration Gas

1. Verify the pump is drawing sample (more than 250 CC/min. if in doubt check the flow with a flow meter range between 250 CC/min and 500 CC/min)
2. Connect the calibration gas to the QRAE II as shown.



### Sensor Calibration Time

The QRAE II is designed to automatically use a predetermined calibration time.

### Zero (Fresh Air) Calibration

This procedure determines the zero point of the sensor calibration curve. Expose the inlet to a clean air source with 20.9% oxygen and without any organic, toxic or combustible gas impurities. This “Zero Air” can be from a cylinder, clean ambient air, or ambient air purified through a charcoal filter.

### Using Fresh Air

**Caution!** Do not use the Calibration Adapter while performing zero calibration in fresh air.

Turn on the QRAE II and follow this procedure:

1. Enter Program Mode.

## QRAE II User's Guide

2. At Calibrate Monitor, press [Y/+].

You should see:

### **Fresh Air Calibration?**

3. Press Y+ to start calibration. Calibration is performed automatically.

### **Using Zero Gas**

1. Attach the regulator to the Zero Gas cylinder.
2. Attach a hose to the Calibration Adapter and to the regulator.
3. Enter Password.
4. At Calibrate Monitor, press [Y/+].
5. When you see Fresh Air Calibration? turn on the regulator to start the Zero Gas flow.
6. Press [Y/+].

You should see a countdown from 30 seconds:

**Calibration  
in progress ... 30**

When calibration is complete, you will see the screen change between these two:

<b>CO: Zeroed</b>		<b>CO: 0ppm</b>
<b>H2S: Zeroed</b>	<b>and</b>	<b>H2S: 0ppm</b>
<b>OXY: Zeroed</b>		<b>OXY: 20.9%</b>
<b>LEL: Zeroed</b>		<b>LEL: 0%LEL</b>

When the zero calibration is successful, the display should show a reading of “20.9” for the oxygen sensor and “0” for all other sensors.

### **Multiple Sensor Calibration**

This function simultaneously determines the second point of the calibration curve for multiple sensors in the monitor. The display counts down from 60 to 0 seconds, and then shows the name of each sensor, whether it passed or failed calibration, and the calibrated value for each sensor.

Select a sensor to calibrate by pressing [MODE] until the sensor's name is highlighted. Then press [Y/+] to toggle the selection on (indicated by an asterisk, \*) or off (no asterisk). To select other sensors to calibrate, press [MODE] until you reach the sensor you want to select. Then press [Y/+].

After you have selected all the sensors you want calibrated, it is time to perform the calibration.

1. Attach the regulator to the Calibration Gas cylinder.

## QRAE II User's Guide

2. Turn on the regulator to start the Calibration Gas flow.
3. Attach a hose to the Monitor gas inlet and to the regulator.
4. Press [MODE] until OK is highlighted.
5. Press [Y/+] to start calibration.

You should see a countdown from 60 seconds:

**Calibration  
in progress ... 60**

**Note:** If you see the following message, check that the gas is flowing and the hose is attached:

**No Gas Flow... Apply gas or hit any key to start.**

When calibration is complete, you will see the screen change between these two:

**Multiple Sensor Calibrated!**

and

**CO = Pass  
H2S = Pass  
O2 = Pass  
LEL = Pass**

A sensor calibration failure is indicated like this:

**CO = Fail  
H2S = Pass  
O2 = Pass  
LEL = Pass**

If a sensor fails, try calibrating again. If calibration fails again, replace the sensor.

### Single Sensor Calibration

This procedure determines the second point of the sensor calibration curve for a single sensor. The display counts down from 60 to 0 seconds, and then shows the name of each sensor, whether it passed or failed calibration, and the calibrated value for each sensor.

Select the sensor to calibrate by pressing [MODE] until the sensor's name is highlighted. Then press [Y/+] to toggle the selection on (indicated by an asterisk, \*) or off (no asterisk).

After you have selected the sensor you want calibrated, it is time to perform the calibration.



## QRAE II User's Guide

1. Attach the regulator to the Calibration Gas cylinder.

**Important!** Make sure you have the correct calibration gas in the correct concentration. Also make sure that the calibration gas is not beyond its “Best when used by” date, which is stamped on the cylinder’s label.

2. Turn on the regulator to start the Calibration Gas flow.
3. Attach a hose to the Monitor gas inlet and to the regulator.
4. Press [MODE] until OK is highlighted.
5. Press [Y/+] to start calibration.

You should see a countdown from 60 seconds:

**Calibration  
in progress ... 60**

**Note:** If you see the following message, check that the gas is flowing and the hose is attached:

**No Gas Flow... Apply gas or hit any key to start.**

If the flow is correct, a pump icon is shown at the right of LCD screen. If the flow is not correct, the pump icon and the red LED flashes and the audible alarm beeps).

## Bump Testing & Calibrating QRAE II (Diffusion Version)

RAE Systems recommends that a bump test be performed on the QRAEII before the monitor is used or being put into service. A bump test is defined as a brief exposure of the monitor to the calibration gas and the sensors to show response and trigger the lowest alarm set point for each sensor.

- The QRAEII Multi Gas detector must be calibrated if it does not pass a Bump Test, or at least once every 180 days, depending on use and sensor exposure to poisons and contaminants.
- Calibration intervals and bump test procedures may vary due to national legislation.

**Note:** Bump test and calibration can also be performed by using the RAE Systems AutoRAE Lite For QRAE II docking station.

# QRAE II User's Guide

## Connecting The Calibration Adapter

The QRAE II is a diffusion monitor and must be calibrated using a fixed-flow regulator. The QRAE II is supplied with a special calibration adapter that covers the gas diffusion ports.

1. Place the Calibration Adapter over the filter area on the front of the QRAE II.
2. Finger-tighten the screw at the center, as shown:

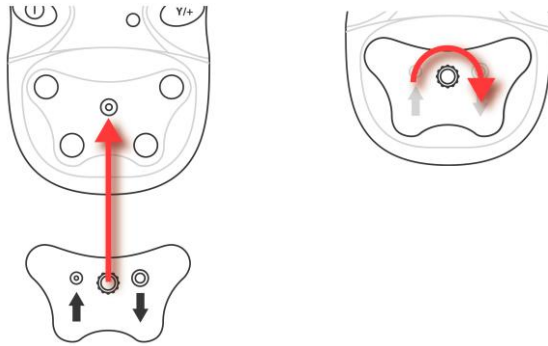

**Note:** Finger-tighten this only. Do not use a pliers or other tools. The Calibration Adapter should be snug, but an air-tight seal is unnecessary.

- 3 Attach the hose from the regulator/calibration gas cylinder to the Calibration Adapter's inlet.

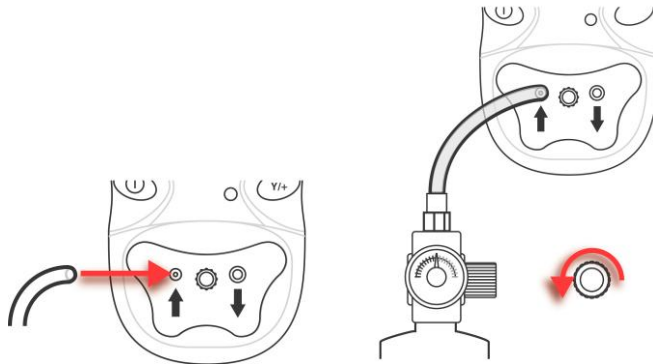

**Caution!** After calibration is complete, remove the Calibration Adapter. When monitoring, never operate the QRAE II with the Calibration Adapter attached. The QRAE II's sensors operate by diffusion. If the Calibration Adapter is attached during normal operation, inconsistent and lower-than-normal readings will occur because of decreased concentration of the gas being monitored.

# QRAE II User's Guide

## Disconnecting The Calibration Adapter

After calibrating the QRAE II, you must remove the Calibration Adapter.

### Sensor Calibration Time

The QRAE II is designed to automatically use a predetermined calibration time. Never operate the QRAE II with the Calibration Adapter attached

To disconnect the Calibration Adapter:

1. Loosen the finger-screw at the center of the Calibration Adapter.

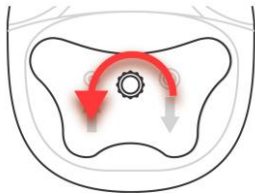

2. Lift the Calibration Adapter from the QRAE II and store it.

## Zero (Fresh Air) Calibration

This procedure determines the zero point of the sensor calibration curve. Expose the inlet to a clean air source with 20.9% oxygen and without any organic, toxic or combustible gas impurities. This “Zero Air” can be from a cylinder, clean ambient air, or ambient air purified through a charcoal filter.

### Using Fresh Air

**Caution!** Do not use the Calibration Adapter while performing zero calibration in fresh air.

Turn on the QRAE II and follow this procedure:

1. Enter Program Mode.
2. At Calibrate Monitor, press [Y/+].

You should see:

### Fresh Air Calibration?

3. Press Y+ to start calibration. Calibration is performed automatically.

### Using Zero Gas

1. Attach the Calibration Adapter to the QRAE II.
2. Attach the regulator to the Zero Gas cylinder.

## QRAE II User's Guide

3. Attach a hose to the Calibration Adapter and to the regulator.
4. Enter Password.
5. At Calibrate Monitor, press [Y/+].
6. When you see Fresh Air Calibration? turn on the regulator to start the Zero Gas flow.
7. Press [Y/+].

You should see a countdown from 30 seconds:

**Calibration  
in progress ... 30**

When calibration is complete, you will see the screen change between these two:

<b>CO: Zeroed</b>		<b>CO: 0ppm</b>
<b>H2S: Zeroed</b>	<b>and</b>	<b>H2S: 0ppm</b>
<b>OXY: Zeroed</b>		<b>OXY: 20.9%</b>
<b>LEL: Zeroed</b>		<b>LEL: 0%LEL</b>

When the zero calibration is successful, the display should show a reading of “20.9” for the oxygen sensor and “0” for all other sensors.

### Multiple Sensor Calibration

This function simultaneously determines the second point of the calibration curve for multiple sensors in the monitor. The display counts down from 60 to 0 seconds, and then shows the name of each sensor, whether it passed or failed calibration, and the calibrated value for each sensor.

Select a sensor to calibrate by pressing [MODE] until the sensor's name is highlighted. Then press [Y/+] to toggle the selection on (indicated by an asterisk, \*) or off (no asterisk). To select other sensors to calibrate, press [MODE] until you reach the sensor you want to select. Then press [Y/+].

After you have selected all the sensors you want calibrated, it is time to perform the calibration.

1. Attach the Calibration Adapter to the QRAE II.
2. Attach the regulator to the Calibration Gas cylinder.
3. Attach a hose to the Calibration Adapter and to the regulator.
4. Turn on the regulator to start the Calibration Gas flow.
5. Press [MODE] until OK is highlighted.
6. Press [Y/+] to start calibration.

You should see a countdown from 60 seconds:

**Calibration  
in progress ... 60**

## QRAE II User's Guide

**Note:** If you see the following message, check that the gas is flowing and the hose is attached:

**No Gas Flow... Apply gas or hit any key to start.**

When calibration is complete, you will see the screen change between these two:

**Multiple Sensor Calibrated!**

and

**CO = Pass**  
**H2S = Pass**  
**O2 = Pass**  
-----  
**LEL = Pass**

A sensor calibration failure is indicated like this:

**CO = Fail**  
**H2S = Pass**  
**O2 = Pass**  
-----  
**LEL = Pass**

If a sensor fails, try calibrating again. If calibration fails again, replace the sensor.

### Single Sensor Calibration

This procedure determines the second point of the sensor calibration curve for a single sensor. The display counts down from 60 to 0 seconds, and then shows the name of each sensor, whether it passed or failed calibration, and the calibrated value for each sensor.

Select the sensor to calibrate by pressing [MODE] until the sensor's name is highlighted. Then press [Y/+] to toggle the selection on (indicated by an asterisk, \*) or off (no asterisk).

After you have selected the sensor you want calibrated, it is time to perform the calibration.

1. Attach the Calibration Adapter to the QRAE II.
2. Attach the regulator to the Calibration Gas cylinder.

## QRAE II User's Guide

**Important!** Make sure you have the correct calibration gas in the correct concentration. Also make sure that the calibration gas is not beyond its “Best when used by” date, which is stamped on the cylinder’s label.

3. Attach a hose to the Calibration Adapter and to the regulator.
4. Turn on the regulator to start the Calibration Gas flow.
5. Press [MODE] until OK is highlighted.
6. Press [Y/+] to start calibration.

You should see a countdown from 60 seconds:

**Calibration  
in progress ... 60**

**Note:** If you see the following message, check that the gas is flowing and the hose is attached:

**No Gas Flow... Apply gas or hit any key to start.**

When calibration is complete, you will see the screen change between these two:

**Multiple Sensor Calibrated!**

and

**CO = Pass  
H2S = Pass  
O2 = Pass  
-----  
LEL = Pass**

If the sensor calibration passes, then you should see this message (shown here for carbon monoxide, CO):

**CO calibration pass!**

If the sensor calibration fails, try calibrating again. If calibration fails again, replace the sensor.

## QRAE II User's Guide

### **WARNING**

To reduce the risk of ignition of hazardous atmospheres, recharge battery only in area known to be non-hazardous. Remove and replace battery only in an area known to be non-hazardous.

### Replacing the QRAE II Li-Ion Battery

**Caution:** Turn off the QRAE II before removing or replacing the battery.

1. Place the QRAE II face-down on a soft surface.
2. Use the hex wrench to loosen each of the three screws by turning them counterclockwise.

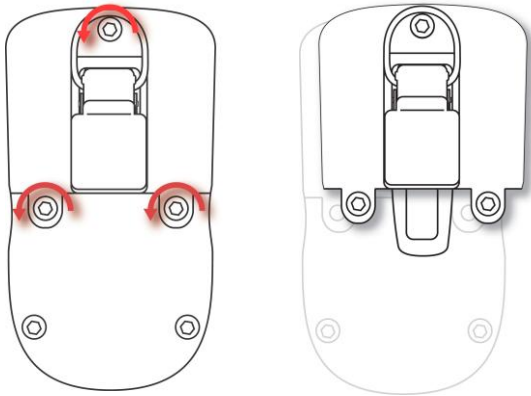

3. Hold the QRAE II down and lift the compartment cover by pulling on the belt clip.
4. Turn the QRAE over and slide the battery out of its compartment.

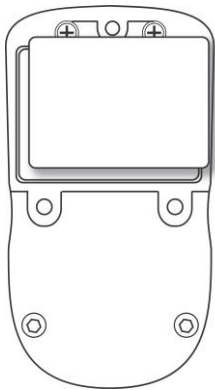

5. Place the new battery into the compartment with its six gold-plated contacts aligned over the six pins.

## QRAE II User's Guide

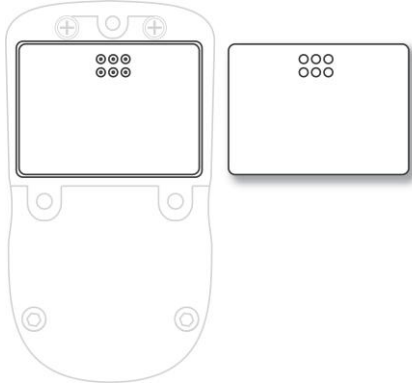

**Note:** Before installing the new battery, visually inspect the contacts to make sure they are clean. If they are not, wipe them with a soft cloth. Do not use solvents or cleaners.

6. Place the cover over the compartment.
7. Tighten all three screws by turning them clockwise with the hex wrench.

### Installing The Alkaline Battery Adapter

The Alkaline Battery Adapter substitutes for the Li-Ion battery. The adapter (part number 020-3403-000) accepts three AA alkaline batteries (use only Duracell MN1500) to provide approximately 12 hours of operation.

1. Place the QRAE II face-down on a soft surface.
2. Use the hex wrench to loosen each of the three screws by turning them counterclockwise.
3. Hold the QRAE II down and lift the compartment cover by pulling on the belt clip.
4. Turn the QRAE over and slide the Li-ion battery out of its compartment.
5. Install three AA alkaline batteries into the Alkaline Battery Adapter, making sure the battery polarity is correct.
6. Place the Alkaline Battery Adapter into the compartment with its six gold-plated contacts aligned over the six pins.
7. Place the cover over the compartment.
8. Tighten all three screws by turning them clockwise with the hex wrench.
9. The monitor automatically detects the alkaline batteries.

### IMPORTANT!

Alkaline batteries cannot be recharged. The QRAE II's internal circuit detects alkaline batteries and will not allow recharging. If you place the QRAE II in its cradle, the alkaline battery will not be recharged, and you will see this icon:



**Note:** When replacing alkaline batteries, dispose of old ones properly.



## QRAE II User's Guide

### **WARNING!**

To reduce the risk of ignition of hazardous atmospheres, recharge the battery only in areas known to be non-hazardous. Remove and replace the battery only in areas known to be non-hazardous.

### **Charging A Spare QRAE II Li-Ion Battery**

A QRAE II Li-ion battery can be charged when it is not inside the QRAE II. The charging cradle is designed to accommodate both types of charging. Contacts on the bottom of the QRAE II battery meet the contacts on the cradle, transferring power without other connections, and two clips hold the battery in place during charging.

1. Plug the AC/DC adapter into the QRAE II's cradle.
2. Place the battery into the cradle, with the six gold-plated contacts on top of the six matching charging pins.
3. Plug the AC/DC adapter into the wall outlet.

The QRAE II battery begins charging automatically. During charging, the LED in the cradle glows red. When charging is complete, it glows green.

Release the battery from the cradle by pressing the keys on both sides of the cradle and lifting the battery out of its slot.

**Note:** If you need to replace the 3.7V Li-ion battery pack, replacements are available from RAE Systems. The part number is 020-3402-000.

**Ordering Replacement Parts:** If you need replacement parts, a list is available online: <http://www.raesystems.com>

## QRAE II User's Guide

### Troubleshooting

Problem	Possible Reasons & Solutions
Cannot turn on power after charging the battery	<p><b>Reasons:</b> Discharged battery. Defective battery.</p> <p><b>Solutions:</b> Charge or replace battery.</p>
No LCD back light	<p><b>Reasons:</b> Trigger level too low, the current mode is not user mode, and the mode does not support automatic turn on back light.</p> <p><b>Solutions:</b> Adjust trigger level. Verify the back light can be turned on. Verify that the backlight is not in manual mode. Call authorized service center.</p>
Lost password	<p><b>Solutions:</b> Call Technical Support at +1 408-752-0723 or toll-free at +1 888-723-4800</p>
Reading abnormally Low	<p><b>Reasons:</b> Dirty filter. Calibration Adapter is attached. Incorrect calibration.</p> <p><b>Solutions:</b> Replace filter. Remove Calibration Adapter. Calibrate the QRAE II.</p>
Buzzer Inoperative	<p><b>Reasons:</b> Bad buzzer.</p> <p><b>Solutions:</b> Check that buzzer is not turned off. Call authorized service center.</p>

# QRAE II User's Guide

## Alarm Signal Summary

**Note:** Backlight automatically turns on when QRAE II alarms.

### Over Range

CO: OPPM  
H2S: OPPM  
OXY: 30.0%  
LEL: 0%LEL

CO: OPPM  
H2S: OPPM  
OXY: OVR  
LEL: 0%LEL

Over Range:  
Buzzer, LED: 3 times/second  
Vibrator: 400ms/second

### High Alarm

CO: OPPM  
H2S: OPPM  
OXY: 25.0%  
LEL: 0%LEL

CO: OPPM  
H2S: OPPM  
OXY: HIGH  
LEL: 0%LEL

High Alarm:  
Buzzer, LED: 3 times/second  
Vibrator: 400ms/second

### Low Alarm

CO: OPPM  
H2S: OPPM  
OXY: 18.3%  
LEL: 0%LEL

CO: OPPM  
H2S: OPPM  
OXY: LOW  
LEL: 0%LEL

Low Alarm:  
Buzzer, LED: 2 times/second  
Vibrator: 400ms/second

### STEL Alarm

CO: OPPM  
H2S: 56PPM  
OXY: 20.9%  
LEL: 0%LEL

CO: OPPM  
H2S: STEL  
OXY: 20.9%  
LEL: 0%LEL

STEL Alarm:  
Buzzer, LED: 1 time/second  
Vibrator: 400ms/second

### TWA Alarm

CO: OPPM  
H2S: 5PPM  
OXY: 20.9%  
LEL: 0%LEL

CO: OPPM  
H2S: TWA  
OXY: 20.9%  
LEL: 0%LEL

TWA Alarm:  
Buzzer, LED: 1 time/second  
Vibrator: 400ms/second

### Negative Drift

CO: OPPM  
H2S: OPPM  
OXY: 20.9%  
LEL: 0%LEL

CO: OPPM  
H2S: NEG  
OXY: 20.9%  
LEL: 0%LEL

Negative Drift:  
Buzzer, LED: 1 time/second  
Vibrator: 400ms/second

### Battery Low

CO: OPPM  
H2S: OPPM  
OXY: 20.9%  
LEL: 0%LEL

Battery Low:  
Buzzer, LED: 1 time/minute  
Vibrator: 400ms/minute

### Battery Dead

Battery low,  
turning off...

Battery Dead:  
LCD display "Battery low,  
turning off..."  
Unit turns off after 15 seconds

### Datalog Full

CO: OPPM  
H2S: OPPM  
OXY: 20.9%  
LEL: 0%LEL

Datalog Full:  
Buzzer, LED: 1 time/second  
Vibrator: 400ms/second



**Arsitec.ch**  
PROTECTING YOU SINCE 1953

**Sicherheit von Kopf bis Fuss**



**Arsitec AG** Industrie Neuhof 25 fon 034 427 00 58 info@arsitec.ch  
3422 Kirchberg BE fax 034 427 00 68 www.arsitec.ch

P/N 020-4100-000 Rev. F  
May 2013